



TECHNICAL REPORT

**Rail Telecommunications (RT);
Future Rail Mobile Communication System (FRMCS);
Interworking study with legacy systems**

Reference

DTR/RT-0066

Keywords

FRMCS, GSM-R, interworking, radio, railways

ETSI

650 Route des Lucioles
F-06921 Sophia Antipolis Cedex - FRANCE

Tel.: +33 4 92 94 42 00 Fax: +33 4 93 65 47 16

Siret N° 348 623 562 00017 - APE 7112B
Association à but non lucratif enregistrée à la
Sous-Préfecture de Grasse (06) N° w061004871

Important notice

The present document can be downloaded from:

<http://www.etsi.org/standards-search>

The present document may be made available in electronic versions and/or in print. The content of any electronic and/or print versions of the present document shall not be modified without the prior written authorization of ETSI. In case of any existing or perceived difference in contents between such versions and/or in print, the prevailing version of an ETSI deliverable is the one made publicly available in PDF format at www.etsi.org/deliver.

Users of the present document should be aware that the document may be subject to revision or change of status.

Information on the current status of this and other ETSI documents is available at

<https://portal.etsi.org/TB/ETSIDeliverableStatus.aspx>

If you find errors in the present document, please send your comment to one of the following services:

<https://portal.etsi.org/People/CommitteeSupportStaff.aspx>

If you find a security vulnerability in the present document, please report it through our
Coordinated Vulnerability Disclosure Program:

<https://www.etsi.org/standards/coordinated-vulnerability-disclosure>

Notice of disclaimer & limitation of liability

The information provided in the present deliverable is directed solely to professionals who have the appropriate degree of experience to understand and interpret its content in accordance with generally accepted engineering or other professional standard and applicable regulations.

No recommendation as to products and services or vendors is made or should be implied.

No representation or warranty is made that this deliverable is technically accurate or sufficient or conforms to any law and/or governmental rule and/or regulation and further, no representation or warranty is made of merchantability or fitness for any particular purpose or against infringement of intellectual property rights.

In no event shall ETSI be held liable for loss of profits or any other incidental or consequential damages.

Any software contained in this deliverable is provided "AS IS" with no warranties, express or implied, including but not limited to, the warranties of merchantability, fitness for a particular purpose and non-infringement of intellectual property rights and ETSI shall not be held liable in any event for any damages whatsoever (including, without limitation, damages for loss of profits, business interruption, loss of information, or any other pecuniary loss) arising out of or related to the use of or inability to use the software.

Copyright Notification

No part may be reproduced or utilized in any form or by any means, electronic or mechanical, including photocopying and microfilm except as authorized by written permission of ETSI.

The content of the PDF version shall not be modified without the written authorization of ETSI.

The copyright and the foregoing restriction extend to reproduction in all media.

© ETSI 2022.
All rights reserved.

Contents

Intellectual Property Rights	5
Foreword.....	5
Modal verbs terminology.....	5
Executive summary	5
Introduction	6
1 Scope	7
2 References	7
2.1 Normative references	7
2.2 Informative references.....	7
3 Definition of terms, symbols and abbreviations.....	9
3.1 Terms.....	9
3.2 Symbols.....	9
3.3 Abbreviations	9
4 FRMCS/GSM-R Interworking principle.....	11
4.1 General concept.....	11
4.2 FRMCS/GSM-R Interworking architectural principles.....	11
4.2.0 General Approach.....	11
4.2.1 Reference points	13
4.2.1.1 General	13
4.2.1.2 Reference point IWF-1 (between the IWF and the MCPTT server)	13
4.2.1.3 Reference point IWF-2 (between the IWF and the MCDATA server).....	13
4.2.1.4 Reference point IWF-3 (between the IWF and the group management server)	13
4.2.1.5 Reference point IWF-g1 (between the IWF and the MSC server/MGCF).....	13
4.2.1.6 Reference point IWF-g2 (between the IWF and MGW).....	14
4.2.1.7 Reference point IWF-g5 (between the IWF and IP-SMS-GW)	14
4.3 FRMCS/GSM-R Interworking addressing	14
4.3.1 Addressing	14
4.3.1.0 General	14
4.3.1.1 SIP URIs and Generic MCX Interworking	14
4.3.2 Key issues related to addressing	15
4.3.3 Potential solutions.....	15
5 The Mg/Mj/Mb Interface between IMS and CS Domain.....	21
5.1 Introduction	21
5.2 Viewpoint of the GSM-R Network	21
5.3 Viewpoint of the MCX System	22
5.4 End to End Use Cases of the Interworking Function FRMCS/GSM-R.....	23
5.4.1 Interworking of point-to-point calls.....	23
5.4.1.1 General	23
5.4.1.2 Key issues	24
5.4.1.3 Potential Solutions	26
5.4.2 Interworking of group calls.....	30
5.4.2.1 General	30
5.4.2.2 Key Issues	31
5.4.2.3 Potential solutions	32
5.4.2.3.1 Interworking of the group call	32
5.4.2.3.2 Interworking talker control in MCPTT and GSM-R	34
5.4.3 Interworking of SMS, MCDATA message	38
5.4.3.1 General	38
5.4.3.2 IWF MCDATA SDS Information Flows.....	38
5.4.3.3 Key issues	39
5.4.3.4 Potential Solutions	39
5.4.4 Interworking related to fixed line dispatcher	40

5.4.4.1	Controller attached to GSM-R vs FRMCS.....	40
5.4.4.1.1	Key issue	40
5.4.4.1.2	Potential solutions	40
Annex A:	Proposal of Translation Rules for eMLPP Parameters.....	42
History		43

Intellectual Property Rights

Essential patents

IPRs essential or potentially essential to normative deliverables may have been declared to ETSI. The declarations pertaining to these essential IPRs, if any, are publicly available for **ETSI members and non-members**, and can be found in ETSI SR 000 314: "*Intellectual Property Rights (IPRs); Essential, or potentially Essential, IPRs notified to ETSI in respect of ETSI standards*", which is available from the ETSI Secretariat. Latest updates are available on the ETSI Web server (<https://ipr.etsi.org/>).

Pursuant to the ETSI Directives including the ETSI IPR Policy, no investigation regarding the essentiality of IPRs, including IPR searches, has been carried out by ETSI. No guarantee can be given as to the existence of other IPRs not referenced in ETSI SR 000 314 (or the updates on the ETSI Web server) which are, or may be, or may become, essential to the present document.

Trademarks

The present document may include trademarks and/or tradenames which are asserted and/or registered by their owners. ETSI claims no ownership of these except for any which are indicated as being the property of ETSI, and conveys no right to use or reproduce any trademark and/or tradename. Mention of those trademarks in the present document does not constitute an endorsement by ETSI of products, services or organizations associated with those trademarks.

DECT™, **PLUGTESTS™**, **UMTS™** and the ETSI logo are trademarks of ETSI registered for the benefit of its Members. **3GPP™** and **LTE™** are trademarks of ETSI registered for the benefit of its Members and of the 3GPP Organizational Partners. **oneM2M™** logo is a trademark of ETSI registered for the benefit of its Members and of the oneM2M Partners. **GSM®** and the GSM logo are trademarks registered and owned by the GSM Association.

Foreword

This Technical Report (TR) has been produced by ETSI Technical Committee Railway Telecommunications (RT).

Modal verbs terminology

In the present document "**should**", "**should not**", "**may**", "**need not**", "**will**", "**will not**", "**can**" and "**cannot**" are to be interpreted as described in clause 3.2 of the [ETSI Drafting Rules](#) (Verbal forms for the expression of provisions).

"**must**" and "**must not**" are **NOT** allowed in ETSI deliverables except when used in direct citation.

Executive summary

Since the first studies on the successor to GSM-R have been launched by UIC in 2012, the rail community has been considering how to meet rail requirements with a future proof and flexible radio communication system.

The rail needs are defined in the User Requirements Specification (URS) [i.1] and the Telecom Onboard Architecture (TOBA) Requirements [i.2] delivered by the UIC Project Future Rail Mobile Communications System (FRMCS). From the UIC requirements, requirements relevant to 3GPP have been captured in 3GPP TS 22.889 [i.3]. Altogether, the stated requirements are the basis for the development of the GSM-R successor.

The present document is a study on FRMCS interworking with GSM-R, which initially analyse potential interworking scenarios and potential solutions applicable for GSM-R.

Introduction

GSM-R has been a great success not only in Europe, where more than 100 000 km of railway tracks are daily operated through GSM-R, but also worldwide, and this number will double within the next years due to the on-going installations of this technology all over the world.

As the needs of the railways are constantly evolving, in particular in the context of the digitalisation of rail operation that is pursued in many countries and considering the upcoming obsolescence of GSM-R technology, UIC launched in 2012 the first studies for a successor to GSM-R, pertinently named Future Rail Mobile Communication System (FRMCS). The UIC project then concretely delivered the new User Requirements Specifications (URS) [i.1] focusing mainly on rail communication needs - as a basis for the development of the GSM-R successor.

The present document is a study on the FRMCS interworking with GSM-R, which defines potential solutions and likely deployment scenarios, and which elaborates on possible technical realizations of the interworking.

1 Scope

The present document analyses the interworking scenario between FRMCS and GSM-R and the solution applicable to GSM-R. The focus is on GSM-R services equivalency such as voice, SMS, data and other services.

The present document presumes the existence of an interworking function IWF between FRMCS and GSM-R, however the IWF and the interface between IWF and GSM-R network are not specified.

ETSI TS 123 283 [i.13] specifies the stage 2 of interworking of MCX Systems with LMR Systems, where the requirements of interworking between FRMCS and GSM-R have not been considered completely.

NOTE: It is assumed that FRMCS is based on MCX Systems and interworking with GSM-R is to be defined on the same basis of the interworking with LMR systems.

The present document reviews this interworking from three viewpoints:

GSM-R	EIRENE specification of services
MCX System	ETSI TS 123 283 [i.13]
FRMCS	3GPP TS 22.889 [i.3]

This study focuses on the identification of key functions, key issues and solutions recommended for way forward resulting in end to end use cases for the IWF.

Prerequisites & Assumptions:

- 1) The interworking and interconnect is based on SIP interface.
- 2) The interworking is based on SIP protocol for signalling and RTP protocol for bearer (G.711 codec and AMR-WB as option).
- 3) The service continuity is not foreseen as per 3GPP TS 22.889 [i.3].
- 4) Cybersecurity is not part of this study.

2 References

2.1 Normative references

Normative references are not applicable in the present document.

2.2 Informative references

References are either specific (identified by date of publication and/or edition number or version number) or non-specific. For specific references, only the cited version applies. For non-specific references, the latest version of the referenced document (including any amendments) applies.

NOTE: While any hyperlinks included in this clause were valid at the time of publication, ETSI cannot guarantee their long term validity.

The following referenced documents are not necessary for the application of the present document but they assist the user with regard to a particular subject area.

- | | |
|-------|---|
| [i.1] | UIC FRMCS URS v5.0: "User Requirements Specification". |
| [i.2] | UIC FRMCS TOBA-7510 (V1.0.0) (April 2020): "FRMCS Telecom On-Board System - Functional Requirements Specification". |
| [i.3] | 3GPP TS 22.889 (V17.2.0) (January 2020): "Study on Future Railway Mobile Communication System (FRMCS)". |

- [i.4] ETSI TS 123 040 (17.2.0): "Digital cellular telecommunications system (Phase 2+) (GSM); Universal Mobile Telecommunications System (UMTS); LTE; 5G; Technical realization of the Short Message Service (SMS) (3GPP TS 23.040 version 17.2.0 Release 17)".
- [i.5] ETSI TS 129 163 (V17.3.0): "Digital cellular telecommunications system (Phase 2+) (GSM); Universal Mobile Telecommunications System (UMTS); LTE; 5G; Interworking between the IP Multimedia (IM) Core Network (CN) subsystem and Circuit Switched (CS) networks (3GPP TS 29.163 version 17.3.0 Release 17)".
- [i.6] ETSI TS 103 389: "Rail Telecommunications (RT); Global System for Mobile communications (GSM); Usage of Session Initiation Protocol (SIP) on the Network Switching Subsystem (NSS) to Fixed Terminal Subsystem (FTS) interface for GSM Operation on Railways".
- [i.7] ETSI TS 123 002 (V17.0.0): "Digital cellular telecommunications system (Phase 2+) (GSM); Universal Mobile Telecommunications System (UMTS); LTE; Network architecture (3GPP TS 23.002 version 17.0.0 Release 17)".
- [i.8] 3GPP TS 23.280 (V17.2.0) (March 2020): "Common functional architecture to support mission critical services; Stage 2".
- [i.9] ETSI TS 123 228 (V16.4.0): "Digital cellular telecommunications system (Phase 2+) (GSM); Universal Mobile Telecommunications System (UMTS); LTE; IP Multimedia Subsystem (IMS); Stage 2 (3GPP TS 23.228 version 16.4.0 Release 16)".
- [i.10] ETSI TS 123 379 (V17.9.0): "LTE; Functional architecture and information flows to support Mission Critical Push To Talk (MCPTT); Stage 2 (3GPP TS 23.379 version 17.9.0 Release 17)".
- [i.11] ETSI TS 123 282 (V17.9.0): "LTE; Functional architecture and information flows to support Mission Critical Data (MCData); Stage 2 (3GPP TS 23.282 version 17.9.0 Release 17)".
- [i.12] ETSI TS 143 068 (V17.0.0): "Digital cellular telecommunications system (Phase 2+) (GSM); Voice Group Call Service (VGCS); Stage 2 (3GPP TS 43.068 version 17.0.0 Release 17)".
- [i.13] ETSI TS 123 283 (V17.3.0): "LTE; Mission Critical Communication Interworking with Land Mobile Radio Systems (3GPP TS 23.283 version 17.3.0 Release 17)".
- [i.14] ETSI TS 102 610 (V17.3.0): "Railways Telecommunications (RT); Global System for Mobile communications (GSM); Usage of the User-to-User Information Element for GSM Operation on Railways".
- [i.15] ETSI GTS GSM 09.02 (V7.15.0) (March 2004): "Digital cellular telecommunications system (Phase 2+) (GSM); Mobile Application Part (MAP) specification (GSM 09.02)".
- [i.16] ETSI TS 123 038 (V17.0.0): "Digital cellular telecommunications system (Phase 2+) (GSM); Universal Mobile Telecommunications System (UMTS); LTE; Alphabets and language-specific information (3GPP TS 23.038 version 17.0.0 Release 17)".
- [i.17] IETF RFC 4412: "Communications Resource Priority for the session Initiation Protocol (SIP)".
- [i.18] IETF RFC 8101: "IANA Registration of New Session Initiation Protocol (SIP) Resource-Priority Namespace for Mission Critical Push To Talk Service".
- [i.19] EIRENE System Requirements Specification, Version 15.1 (2010).

3 Definition of terms, symbols and abbreviations

3.1 Terms

For the purposes of the present document, the following terms apply:

IMPU: IMS Public User Identity in the form of a SIP URI

NOTE 1: The domain part of the IMPU is equal to the domain of the IMS.

NOTE 2: An IMS subscription support one or more IMPUs.

MCX: all MC services standardized by 3GPP that are foreseen for interworking with GSM-R in the FRMCS

NOTE: Only MCX services related to Voice and Data are considered.

MCX IDs: users and groups of all MC services standardized by 3GPP

NOTE 1: MCX IDs include MCPTT ID, MCPTT group ID, MCDData ID and MCDData group ID.

NOTE 2: MCX IDs are always defined in the form of SIP URIs.

3.2 Symbols

Void.

3.3 Abbreviations

For the purposes of the present document, the following abbreviations apply:

AMR	Adaptative Mobile Rate
AMR-WB	Adaptative MultiRate-Wide Band
AoCC	Advice of Charge Charging
AoCI	Advice of Charge Information
AS	Application Server
BAIC	Barring All Incoming Calls
BAOC	Barring All Outgoing Calls
BGCF	Breakout Gateway Control Function
BIC	Barring Incoming Call
BICC	Bearer-Independent Call Control
BOIC	Barring of Outgoing International Calls
CCBS	Call Control for Busy Subscriber
CFB	Call Forwarding Busy
CFNRc	Call Forwarding Not Reacheable
CFNRy	Call Forwarding No Reply
CFU	Call Forwarding Unconditional
CLIP	Calling Line Identity Presentation
CLIR	Calling Line Identification Restriction
CoLP	Connected Line Identification Presentation
CoRL	Connected Line Identification Restriction
CS	Circuit Switch
CSC	Control Signalling Code
CSCF	Circuit Switch Control Function
CT-7	Call Type 7
CUG	Closed User Group
CW	Call Waiting
DNS	Domain Name Server
ECT	Explicit Call Transfer
EiNUM	tElephone IP NUMber mapping
EIRENE	European Integrated Radio Enhanced NEtwork

eMLPP	Enhanced Multi-Level Precedence and Pre-emption
ENUM	telephone NUMber mapping
eREC	enhanced Railway Emergency Call
EVS	Enhanced Voice Service
exHC	except Home Country
FA	Functional Address
FA/FN	Functional Address/Functional Number
FN	Functional Number
FRMCS	Future Railway Mobile Communications System
GC	Group Call
GCR	GSM Call Register
GPS	Global Positioning System
GSM	Global System for Mobile communications
GSM-R	Global System for Mobile communications - Railway
GW	GateWay
HLR	Home Location Register
I-CSCF	Interrogating-Call Session Control Function
ID/MC	Identifier/Mission Critical
IM-MGW	IMS MediaGateWay
IMPU	IMS Public User identity
IMS	IP Multimedia Subsystem
IoT	Internet of Things
IP	Internet Protocol
IP-SMS	Internet Protocol Short Message Service
ISC	International Switching Center
IWF	Interworking Function
LDA	Location Dependant Addressing
LMR	Land Mobile Radio
MAP	Mobile Application Protocol
MC	Mission Critical
MCDATA	Mission Critical Data
MCPTT	Mission Critical Push To Talk
MCX	Mission Critical Services
MCX-ID	Mission Critical Service Identifier
MGCF	Mobile Gateway Communication Function
MGW	Media GateWay
MLPP	Multi-Level Precedence and Pre-emption
MOC	Mobile Originated Call
MPTY	Multi ParTY service
MRFP	Media Resource Function Protocol
MS	Mobile Station
MSC	Mobile Switching Center
MSC-S	Mobile Switching Center-Serving
MSISDN	Mobile Station International ISDN Number
NG	Next Generation
OTDI	Originator to Dispatcher Information
P2P	Point 2 Point
PABX	Private Automatic Branch eXchange
PAI	P-Asserted Identity
P-CSCF	Proxy-Call Session Control Function
REC	Railway Emergency Call
RPH	Retention Priority Handling
RTP	Real-time Transport Protocol
SA1	Service Aspect 1
SCP	Service Control Point
S-CSCF	Serving-Call Session Control Function
SDP	Session Description Protocol
SDS	Short Data Service
SIM	Subscriber Identity Module
SIP	Session Initiation Protocol
SM	Short Message
SME	Short Message Entity

SMPP	Short Message Peer-to-Peer protocol
SMS	Short Message Service
SMSC	Short Message Service Center
TCP/IP	Transmission Control Protocol/Internet Protocol
TE	Terminat Equipment
TOBA	Telecom On-Board Architecture
UIC	Union Internationale des Chemins de fer
URI	Uniform Resource Identifier
URS	User Requirements Specification
USSD	Unstructured Supplementary Service Data
UUI	User to User Information
UUIE	User to User Information Element
UUS	Unstructured Supplementary Service
UUS1	User-to-User Signalling type 1
VBS	Voice Broadcast Service
VGCS	Voice Group Call Service
XML	eXtensible Markup Language

4 FRMCS/GSM-R Interworking principle

4.1 General concept

The IWF is distributed over the SIP/IMS Core and the MCX AS.

An FRMCS/GSM-R specific SIP Profile (also known as SIPCORE) is to be defined for the Mg/Mj/Mb interface between IMS Domain and CS Domain to allow interworking of railway specific services between FRMCS and GSM-R:

- Based on ETSI TS 129 163 [i.5] (MGCF), enhanced by parts of ETSI TS 103 389 [i.6] (SIP-R), and potentially other enhancements.

The FRMCS UE is to be built on top of MCX UE.

The FRMCS AS is to be built on top of MCX AS.

4.2 FRMCS/GSM-R Interworking architectural principles

4.2.0 General Approach

The main objective of the present document is to identify the use cases to be considered for interworking. Then, for all the identified use cases, solutions suitable for interworking between mission critical systems and GSM-R systems are proposed.

The goal of the present document is to define the reference points that are between the IWF and the MC service servers and the reference points that are between the IWF and the GSM-R nodes. Additionally it defines the functionality of the IWF, which acts as an MC service server connecting with the MC service server utilizing the IWF-1 or IWF-2 reference points, including protocol translation, identity mapping, transcoding, routing and so on to be performed by the IWF between the reference points on the MC service side to the GSM-R side and vice versa.

The IWF provides centralised support for interworking between an MCPTT or MCDData system and a GSM-R system. In MCPTT or MCDData systems, the identity of a GSM-R user is provided as an MCPTT or MCDData ID, and the identity of a GSM-R group is provided as a MCPTT or MCDData group ID, which is to be used by the IWF to derive the corresponding identities used in the GSM-R system and vice versa.

The IWF performs the identity mapping between an MCPTT system or MCDData system and a GSM-R system during exchange of signalling and media messages.

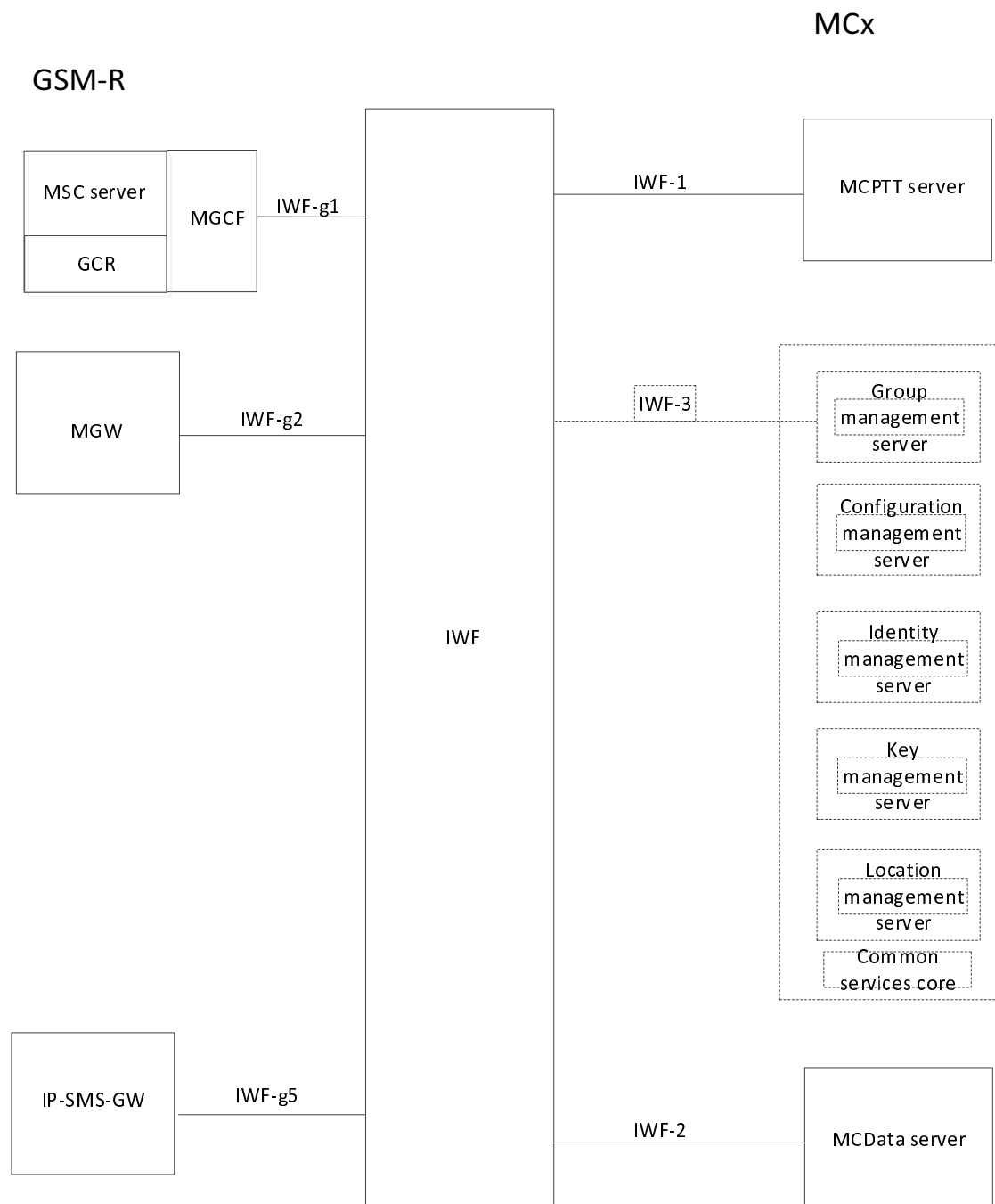

Figure 1: Functional model for application plane for interworking

Figure 1 illustrates the functional model for application plane for interworking between GSM-R and MCPTT and MCData. It is based on ETSI TS 123 283 [i.13]. The protocols on any reference point that is exposed for MCPTT service interoperability with other SIP core or other IMS entities in other systems is to be compatible with the protocols defined for the corresponding reference point defined in ETSI TS 123 002 [i.7].

From 3GPP TS 23.280 [i.8]:

"The SIP core shall be either:

1. compliant with ETSI TS 123 228 [i.9], i.e. the SIP core is a 3GPP IP multimedia core network subsystem; or
2. a SIP core, which internally need not comply with the architecture of ETSI TS 123 228 [i.9], but with the reference points that are defined in subclause 7.5.3 (if exposed), compliant to the reference points defined in ETSI TS 123 002 [i.7]."

4.2.1 Reference points

4.2.1.1 General

The SIP core as mentioned above does not need to be compliant to the IMS architecture, but the reference points is to be derived from IMS specific reference points as shown in Table 1.

Table 1: Proposed mapping of reference points on GSM-R side according to ETSI TS 129 163 [i.5]

Original IMS reference point	Derived IWF-gx reference point
Mg/Mj	IWF-g1
Mb	IWF-g2
ISC	IWF-g5

4.2.1.2 Reference point IWF-1 (between the IWF and the MCPTT server)

The IWF-1 reference point, which exists between the IWF and the MCPTT server, provides peer to peer interconnection between a GSM-R system and the MCPTT system. IWF-1 supports a subset of MCPTT-3 as defined in ETSI TS 123 379 [i.10], with some differences. The IWF-1 interface is supported by the same signalling plane protocol(s) as defined for MCPTT-3. Floor control signalling and media are also transferred using the IWF-1 reference point.

4.2.1.3 Reference point IWF-2 (between the IWF and the MCDData server)

The IWF-2 reference point, which exists between the IWF and the MCDData server, provides SDS interconnection between a GSM-R system and the MCDData system. IWF-2 supports a subset of the functionality of MCDData-SDS-1 and MCDData-SDS-2, as defined in ETSI TS 123 282 [i.11] with some differences. The IWF-2 interface is supported by the same signalling plane protocol(s) as defined for MCDData-3 except.

4.2.1.4 Reference point IWF-3 (between the IWF and the group management server)

The IWF-3 reference point, which exists between the IWF and the group management server, provides group management interconnection between an GSM-R system and the MC service system. IWF-3 is based upon CSC-16, as defined in 3GPP TS 23.280 [i.8] with some differences.

4.2.1.5 Reference point IWF-g1 (between the IWF and the MSC server/MGCF)

The IWF-g1 reference point, which exists between the IWF and the MSC server via MGCF, provides signalling plane for voice communication based on implementation of the reference point Mg/Mj as defined by ETSI TS 129 163 [i.5].

Additional information on GCR from ETSI TS 143 068 [i.12]:

"The general architecture of GSM is maintained. In addition, a network function is required which is used for registration of the group call attributes, the Group Call Register (GCR)".

The protocol for GCR is not specified, but the interface is standardized.

NOTE: The GCR implementation is not specified. It is to be realized e.g. as a new network node, in a PABX directly attached to an MSC, inside an MSC or as an HLR. The interface between the GCR function and other functions is not specified in the GSM technical specifications. As a consequence, the functional split between MSC and GCR as developed in the present document is only indicative.

The GCR data for a specific voice group call is set at the creation of the group call attributes, and is to be subsequently modified. No support for these functions is specified in the GSM technical specifications.

In a RANflex configuration with group call redundancy GCRs associated to MSCs belonging to the same redundancy pool need to communicate with each other by means of SYNC_GCR messages.

4.2.1.6 Reference point IWF-g2 (between the IWF and MGW)

The IWF-g2 reference point, which exists between the IWF and the MGW, provides media plane protocol for voice communication.

4.2.1.7 Reference point IWF-g5 (between the IWF and IP-SMS-GW)

The IWF g5 reference point exist between the IP-SMS-gateway on the GSM-R side and the IWF.

Since the assumption is that SIP interfaces are used the IP-SMS-GW is introduced on the GSM-R side to convert the SMPP MAP protocol to SIP (ISC).

4.3 FRMCS/GSM-R Interworking addressing

4.3.1 Addressing

4.3.1.0 General

The addressing relies on ETSI TS 123 283 [i.13] LMR specification to minimize potential impact on GSM-R side.

The IWF is to be the placeholder for adaptation to keep GSM-R untouched and most of the work is to be done on the IMS side.

4.3.1.1 SIP URIs and Generic MCX Interworking

One main aspect of the interworking is the fact that different types of identities are used in FRMCS and in GSM-R. The IWF plays a main role here as it performs the conversion of the IDs used in FRMCS and those used in GSM-R. The IWF is capable to convert both physical and functional IDs in both systems.

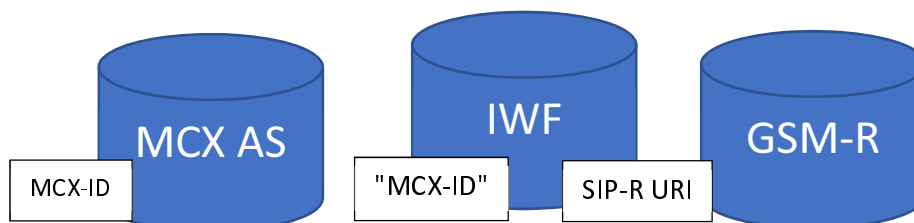

Figure 2: Functional model for interworking functional alias/addressing

Example, from MCX system to GSM-R:

- 1) Incoming "MCX ID":
 - a) Identify entities (users, groups) on the MCX System.
- 2) Outgoing ID:
 - a) Identify entities (users, services) on the GSM-R System.
- 3) Incoming and outgoing IDs are either a physical ID (holding a physical address according to E.164 or a MCX ID) or a functional ID (holding a functional number according EIRENE or a holding an MCX Functional Alias).

For GSM-R the MSISDN (mobile/fixed) could be registered for functional numbers using the SCP of the GSM-R into IN database. In FRMCS the MC Service User ID/MC Service ID could be activate for several functional alias into configuration management Server including functional alias management server database.

Both, functional numbers and functional alias are reflecting railway specific roles (e.g. dispatcher, Train xy coach z) for telecommunication services and needs to be mapped to the technic corresponding public user identity (MSISDN /MCX User ID).

There are three possible scenarios for translating interwork functional alias which could be applied, further details in clause 4.3.3

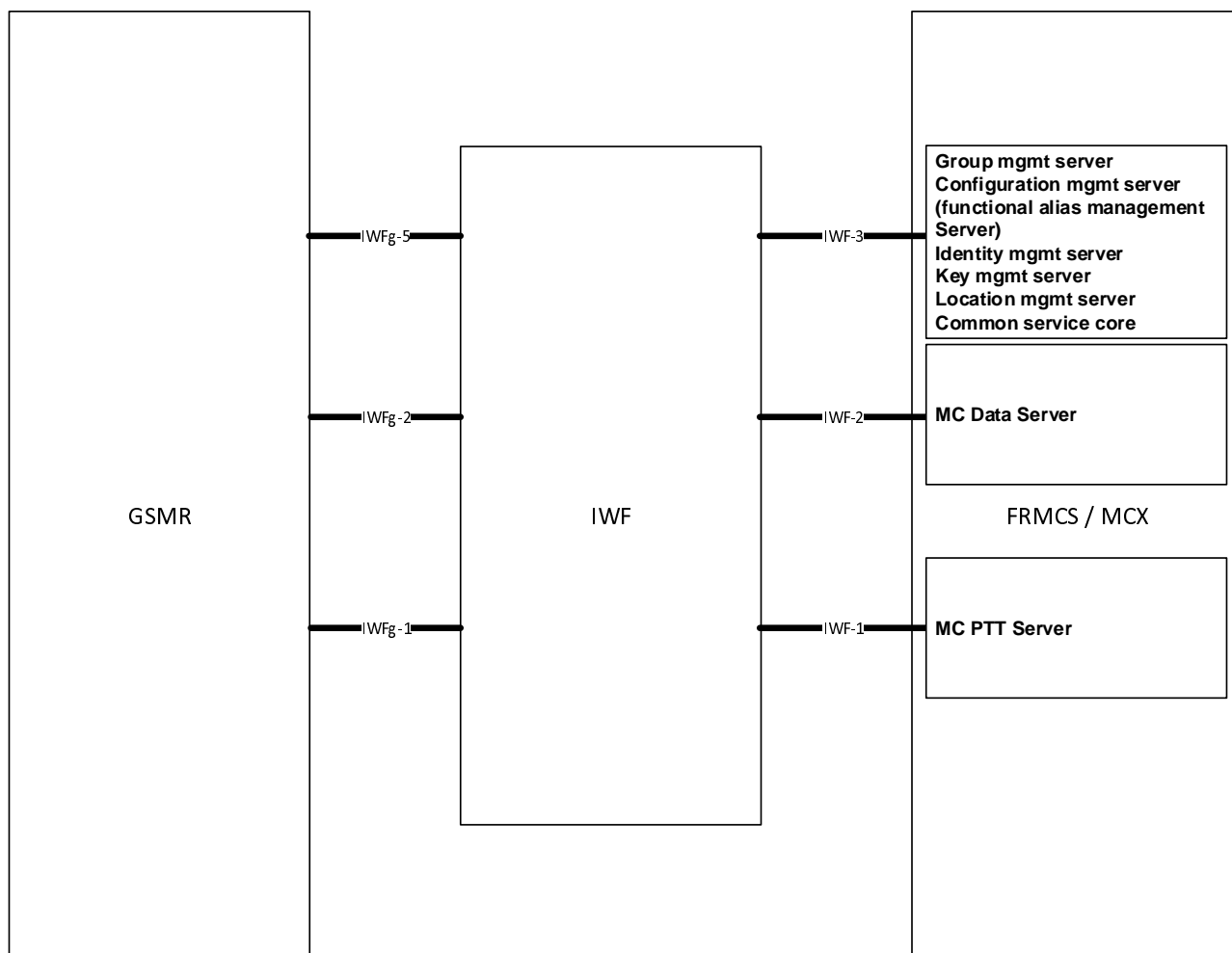

Figure 3: Functional model for interworking functional alias/addressing

Figure 3 illustrates the functional model for signalling (IWFg-1) and media plane (IWFg-2) for interworking between GSM-R and MCPTT and MCData.

4.3.2 Key issues related to addressing

- Identify and define criteria to route id towards IWF or not.
- Routing decision.

4.3.3 Potential solutions

Rule based mapping

Addressing Principles:

- **Clear Mapping Rules to be standardized between FNs (EIRENE numbers) and FA (FRMCS Functional Aliases)**, so that a transformation of addresses is to be done without inquiry at the Configuration Management Server.

- **FA(164):** FRMCS FAs to be introduced that describe international E.164 numbers.

FA(EIRENE): suggestion is FRMCS FAs are to be introduced that describe international EIRENE numbers (to enable calls from FRMCS user to GSM-R FNs that do not have an "equivalent" FRMCS FA).

This could be useful e.g. for the breakout into the public network via GSM-R R4.

FRMCS SIP URI Convention

When interpreting SIP URIs as FRMCS/GSM-R addresses, the IWF detect in all cases from the context, if a SIP URI is to be inter-pre-ted as FRMCS MCX ID or as FRMCS FA or as something else. This knowledge is to be seized by the IWF always, if available.

Examples for the Suggested FRMCS URI Scheme:

Functional Aliases (at ISC interface and Gm):

FA(164): <sip:+435025587100234@oebb.at;user=phone>

FA(EIRENE): <sip:0435020199299@oebb.at;user=gsmr>

FA: <sip:MainController.67890@oebb.at>

NOTE 1: This approach implies that "function" and "type" of the FRMCS FAs start with an alpha character and are distinct and unique.

NOTE 2: The types of FAs is to be recognized by one of two mechanisms:

First letter of user part ('+', [0-9] or alpha character);

User parameter "user=gsmr|phone|dialstring|ip" (preferred solution).

MCPTT ID (at ISC interface and Gm)

sip: walter@oebb.at

SIP URI Convention (at Mg/Mj) - ETSI TS 103 389 [i.6]

E.164 <sip:+435025587100234@oebb.at;user=phone>

EIRENE <sip:0435020199299@oebb.at;user=gsmr>

Table 2: Example for the Mapping between GSM-R FN and FRMCS FA

Use Case	FN (GSM-R)	Calls FA (FRMCS) via IWF	Example
LDA	CT1 to CT7	Controller Identity (first-to-answer) Function.Location@CC	PrimaryController.12345@oebb.at
Train Number	CT2	Train Identity (first-to-answer) Function.TrainNumber@CC	LeadingDriver.54321@oebb.at
Engine Number	CT3	Vehicle Identity (first-to-answer)	Details Tbd.: <function>.equipment.EVN@oebb.at
Coach Number	CT4	Vehicle Identity (first-to-answer)	Details Tbd. <function>.equipment.EVN@oebb.at
VGCS/VBS	CT5	Profile Addressing (prearranged) Profile.Location@CC	traindrivers.12345@oebb.at
Shunting Team	CT6	Team Identity (first-to-answer) Function.Type.Location@CC	TeamMember2.Shunting1.12345@oebb.at
Calling the Controller	CT7	Controller Identity (first-to-answer) Function.Location@CC	MainController.12345@oebb.at
Calling a MSISDN	E.164 to CT8	FA (164) (private)	+43502550001@oebb.at

The following FRMCS FAs are not reachable by GSM-R FNs as without equivalent in GSM-R:

- Equipment Identity (IoT is new).
- Some Functions of:
 - Train Identity
 - Controller Identity
 - Team Identity
- Some Profiles of Profile Addressing (those without equivalent GSM-R FN).

NOTE 3: It may not be needed to normalize the above as no IWF is foreseen on unknown element to GSM-R.

Table 3: Example of mapping FRMCS Service with GSM-R Service

Use Case	FA (FRMCS)	Calls FN (GSM-R)
Vehicle Identity	Function.Equipment.EVN@CC	CT3/CT4
LDA -> Controller Identity	Function.Location@CC	CT7 (user=gsmr)
Controller Identity	Function.Location@CC	CT7 (user=gsmr)
Train Identity	Function.TrainNumber@CC	CT2 (user=gsmr)
Team Identity	Function.Type.Location@CC	CT6 (user=gsmr)
Profile Addressing	Profile.Location@CC	CT5 (user=gsmr)
Call FA/FN	Equivalent FA	Equivalent FN (user=gsmr)
Direct Call FN	FA(EIRENE)	FN (user=gsmr)
Direct Call E.164	FA(164)	E.164 (CT8/CT9) (user=phone)

Mapping Rules for Called Address and Calling Address for FRMCS Terminating Calls

The following two scenarios (I and II) for Translation from GSM-R to FRMCS are considered:

- I.) Called Number is E.164:
 - I.a) Calling Number (From) is E.164/UUIE holds Calling FN.
 - I.b) Calling Number (From) is CT5/UUIE holds OTDI.
- II.) Called Number is FN (CT2/3/4/5/6/7):
 - II.a) Calling Number (From) is E.164/UUIE holds Calling FN.
 - II.b) Calling Number (From) is CT5/UUIE holds OTDI.

Handling of Called Address is depicted in Figure 4. The red and green text below is related to the green and red lines in Figure 4 and corresponds to the 2 scenarios above identified.

Called Address is mapped by MGCF as follows:

- an E.164 ==> MGCF sends to IWF in Request-URI and To-Header a SIP URI according to ETSI TS 103 389 [i.6]: CT8 address, optionally CT9 or E.164
- an FN ==> MGCF sends to IWF in Request-URI and To-Header a SIP URI according to ETSI TS 103 389 [i.6]: FN (CT2/3/4/5/6/7) address

IWF translates Request URI and ignores To Header:

- Req-URI = CT8/CT9/E.164 ==> destination FA(164) in XML Body
- Req-URI = FN ==> destination FA (straight forward mapping algorithm into XML Body)

MCX AS delivers MCX ID/resolves FA (dependent on scenario):

- Resolves FA (164) and delivers MCX ID to registered IMPU
- Resolves FA and delivers to resulting MCX ID

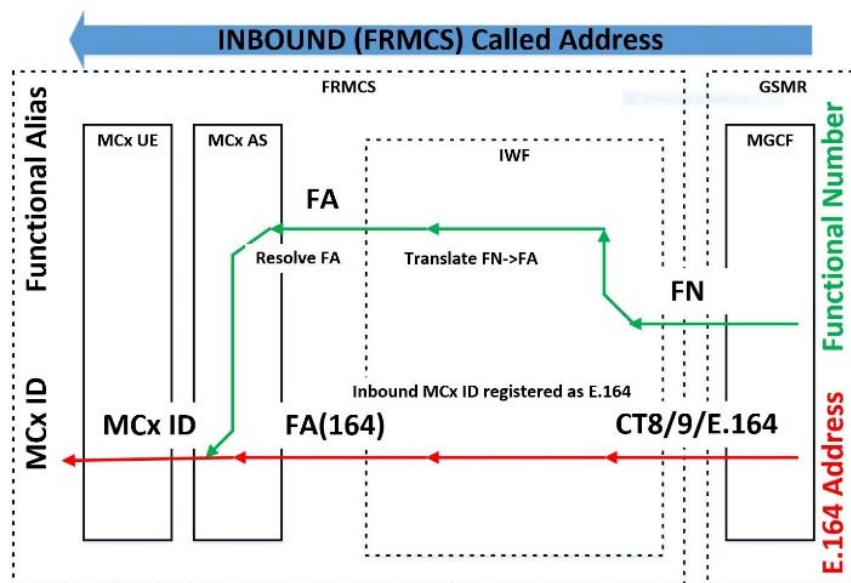

Figure 4: Called Addresses (functional and physical) in an FRMCS Terminating Call

Handling of Calling Address is depicted in Figure 5. The red and green text below is related to the green and red lines in Figure 5.

Depending on the scenario, the MGCF sends the following values to describe calling address and additional calling address:

- GSM-R point-to-point call to FRMCS user
E.164 calling party in PAI and From Header (ETSI TS 129 163 [i.5])
calling FN in User-To-User Header (ETSI TS 103 389 [i.6])
- GSM-R VGCS/VBS includes FRMCS User as terminating dispatcher
E.164 calling party in PAI (ETSI TS 129 163 [i.5]),
CT5 FN in From Header (ETSI TS 103 389 [i.6]),
calling OTDI in User-To-User Header (ETSI TS 103 389 [i.6] & ETSI TS 102 610 [i.14]).

IWF translates as follows:

- User-To-User Header is forwarded transparently to FRMCS User
- E.164 from the From Header ==> calling MCX ID in XML Body
- FN from the From Header ==> calling FA in XML Body (straight forward mapping algorithm)
- If no FN in From Header ==> try to map FN/OTDI from User-To-User header ==> calling FA

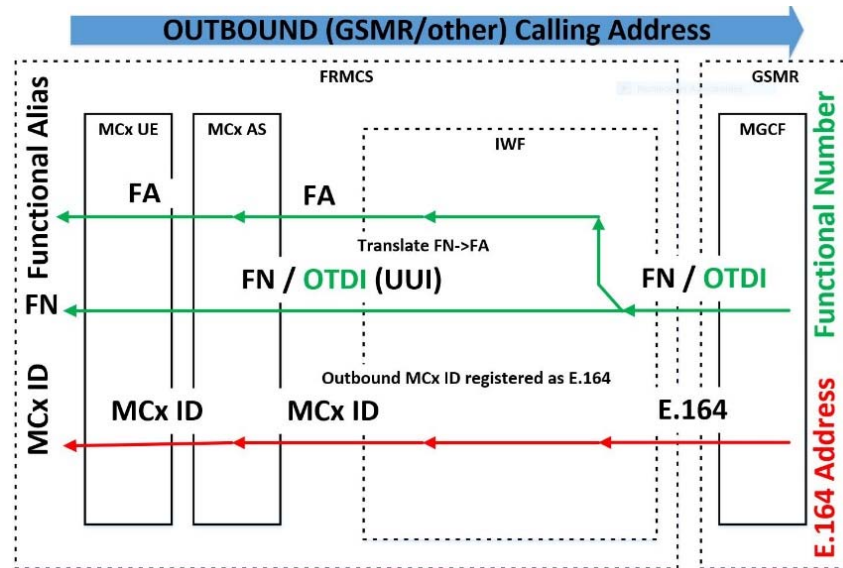

Figure 5: Calling Addresses (functional and physical) in an IMS Terminating Call

NOTE 4: It will not be possible to map EVERY UUI to an FA as UUI is transparent per definition.

Mapping Rules for Called Address and Calling Address for FRMCS Originating Calls

The translation rules for Called Addresses are depicted in Figure 6.

The FRMCS User calls either:

- An MCX ID (without knowing, whether the MCX ID is external or internal).
- An FA(164) - an equivalent of a global E.164 address.
- An FA(EIRENE) - an equivalent of a global EIRENE FN.
- A FA - to be resolved to an MCX ID by AS or to be translated to an FN by IWF.

For each called FA, the MCX AS decides:

- Whether the FA is to be resolved, or is to be forwarded to the IWF.

For each called MCX ID, the MCX AS decides:

- Whether the MCX ID is to be delivered within MCX or is to be forwarded to the IWF.

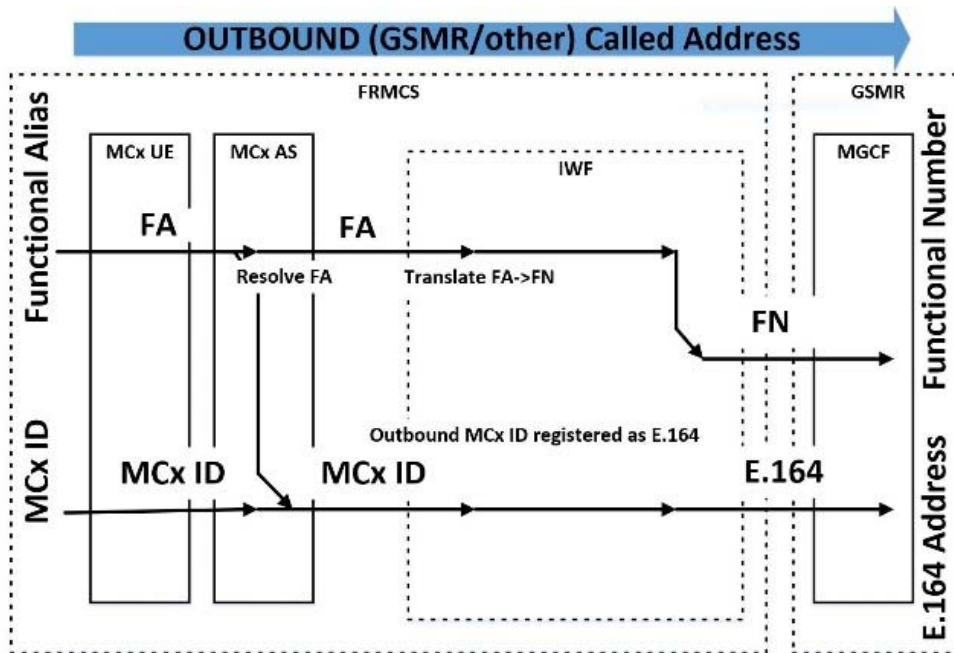

Figure 6: Called Addresses (functional and physical) in an MOC

The translation rules for Calling Addresses are depicted in Figure 7. In any case, the calling MCX ID is translated by the IWF into an E.164 number, which is sent in the PAI header to the MGCF according to ETSI TS 103 389 [i.6] format. If the INVITE message contains a User-To-User header, this is to be forwarded transparently, otherwise the IWF take the calling FA from the XML Body and try to create a User-To-User header with a calling FN.

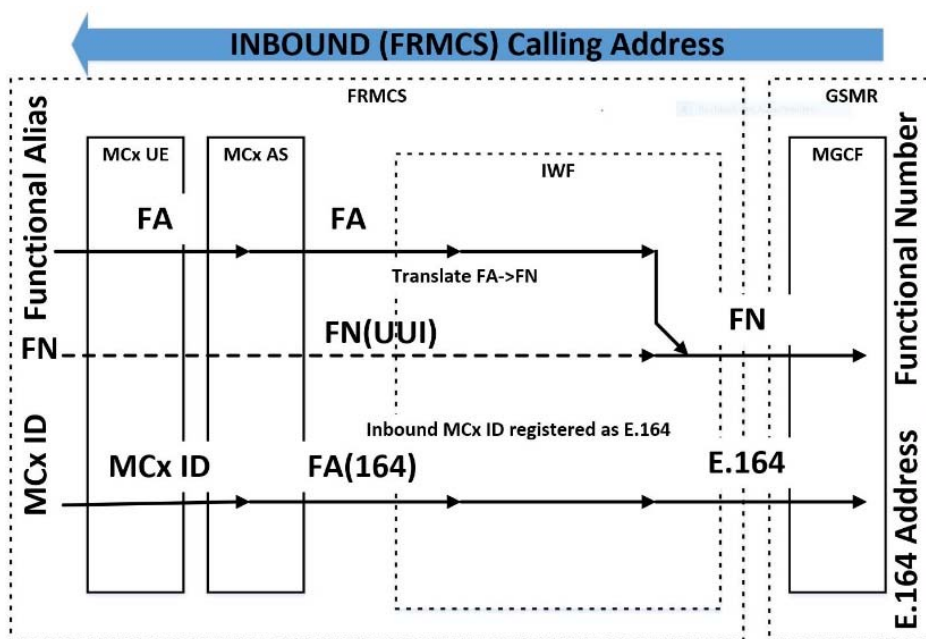

Figure 7: Calling Addresses (functional and physical) in an MOC

5 The Mg/Mj/Mb Interface between IMS and CS Domain

5.1 Introduction

Figure 8 below shows the interface between the IMS and the CS domain.

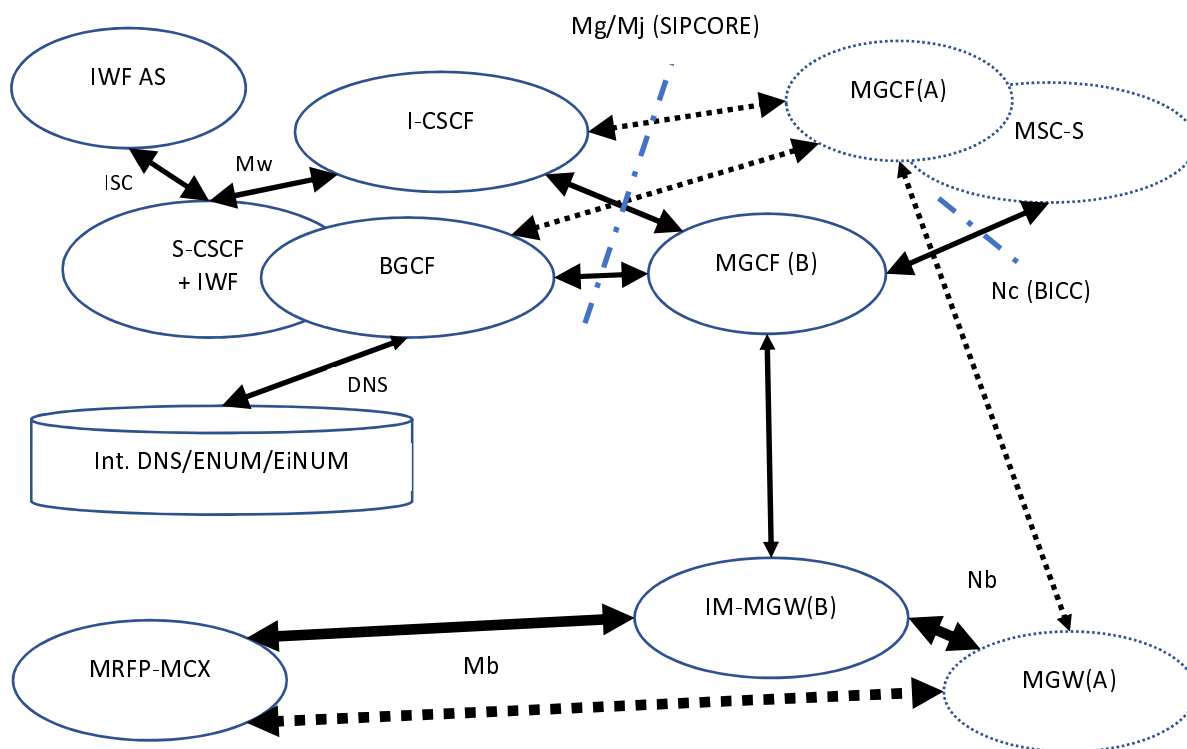

Figure 8: Interfaces between IMS and CS domain

- A) The MGCF + IM-MGW is considered to be a part of the GSM-R network -> Mg/Mj/Mb is external I/F.
- B) The MGCF + IM-MGW is considered to be a part of the FRMCS network -> Nc/Nb is external I/F.

It is assumed that SIP core as defined in 3GPP TS 23.280 [i.8] is used.

5.2 Viewpoint of the GSM-R Network

Table 4 lists all services of GSM-R as defined by EIRENE and their relevance for the interworking between FRMCS and GSM-R.

Table 4: GSM-R services with respect to GSM-R/FRMCS Interworking

Services	Needed (YES/NO)	Remark
CS Bearer Services		
Teleservices		
Speech	YES	
Short Message Service (SMS)	YES	For the interworking of GSM-R SMS and the MC Data SDS the following one-to-one interworking cases are considered: 1) GSM-R SMS to MCDData SDS 2) MCDData short message from MCDData user to GSM-R Subscriber
Facsimile Transmission	NO	
Voice Group Service (VGCS, VBS)	YES	
GSM Supplementary Services		
CLIP	YES	
CLIR	NO	
CoLP	YES	
CoRL	NO	
Call Forwarding	YES	CFU, CFB, CFNRy, CFNRc
Call Waiting (CW)	NO	
Call Hold (HOLD)	YES	
Multi Party Service (MPTY)	NO	
Closed User Group (CUG)	NO	
Advice of Charge (Information) (AoCI)	NO	
Advice of Charge (Charging) (AoCC)	NO	
Barring	NO	BAOC, BOIC, BOIC-exHC, BAIC, BIC-Roam
Unstructured Supplementary Service Data (USSD)	NO	USSD related to UE -HLR, USSD to reach IWF function. Use case related to Border Crossing
Follow Me	NO	Use case related to Border Crossing, call part and registration part
Sub-Addressing	YES	
eMLPP	YES	MLPP vs eMLPP
ECT	YES	Potentially needed for notification in case dispatcher forward
Completion of Calls to Busy Subscribers (CCBS)	NO	
User-to-User Signalling (UUS1)	YES	
Railway Specific Services		
Functional Addressing	YES	
Location Dependent Addressing	NO	
Shunting Mode	NO	
Multiple Driver Communications	NO	
REC	YES	
eREC	NO	

5.3 Viewpoint of the MCX System

Table 5 lists all the services of MCX Systems and their relevance for the interworking between MCX Systems and LMR Systems according to ETSI TS 123 282 [i.11].

Table 5: MCX System services with respect to GSM-R/FRMCS Interworking

Services	Needed (YES/NO)	Remark
Group Affiliation	YES	
Group Information	NO	
Pre-arranged Group Call	YES	
Group Broadcast	YES	
Chat Group Call	NO	
Private Call	YES	Interworking with VGCS, VBS, E.164 and FN
Floor Control	YES	
Emergency	YES	
Imminent Peril Call	NO	
Emergency Alert	YES	
MC Data SDS (one-to-one)	YES	Two Interworking cases: 1) GSM-R SMS to MCDData SDS 2) MCDData SDS from MCDData user to GSM-R Subscriber
Security Interworking and Key Management	NO	
Location	NO	
Functional Alias Management	YES	
First-to-answer Call Setup	NO	

5.4 End to End Use Cases of the Interworking Function FRMCS/GSM-R

5.4.1 Interworking of point-to-point calls

5.4.1.1 General

This clause describes the main differences between GSM-R system and FRMCS system from P2P/private call (P2P call is GSM-R terminology, private call is FRMCS terminology - see Figures 9 and 10) initiation point of view and also defines the key issue and discovered gaps.

Handling of the P2P/private calls in GSM-R system and FRMCS system is different in many aspects.

For calls initiated in GSM-R system by the built-in call handling software on the GSM-R device, the GSM-R user dials only numbers (either E.164 or EIRENE format).

For calls initiated in FRMCS system by the MC client application pre-installed on the device, the FRMCS user initiate private voice calls with MC client ID (URI format).

**Figure 9: P2P call initiation from GSM-R towards FRMCS****Figure 10: Private call initiation from FRMCS towards GSM-R**

Table 6 below highlights the differences in GSM-R and FRMCS when making a call.

Table 6: GSM-R versus FRMCS behaviour

GSM-R	FRMCS
Implicit registration when device is turned on For certain rules also explicit registration is required	User needs to do registration into the MC client application
P2P calls to be initiated from the device native software	Private calls to be initiated from MC client application
Only numbers to be dialled	URI format to be called
No concept of presence, call to be initiated towards each user at any time Access Matrix and Call Screening Function allowing or restricting calls are depending on functional registrations, but not on user availability	
Several 3GPP codecs are supported, but G.711 is usually used in core network	Only AMR-WB and EVS are supported
GSM-R P2P calls are bi-directional	
Only cell ID based location	GPS location or hybrid location to be used

The following clauses will describe key issues and possible solutions for the interworking between GSM-R and FRMCS.

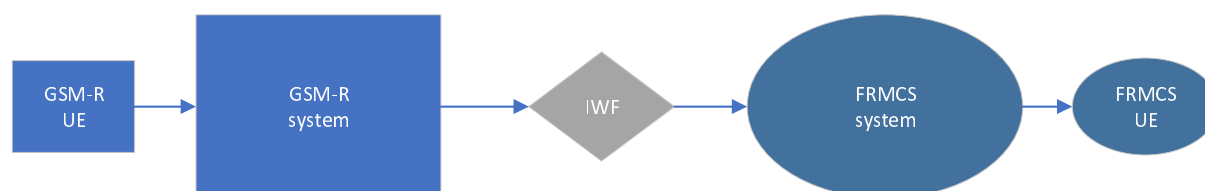
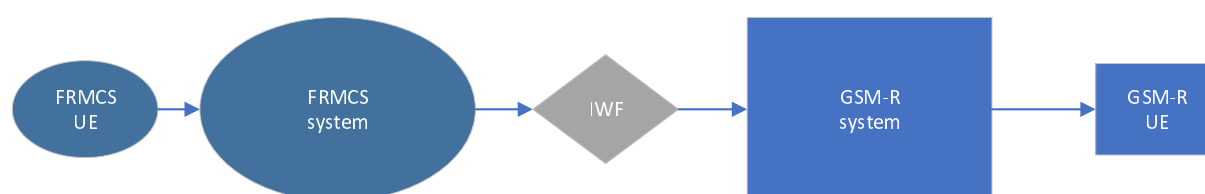
5.4.1.2 Key issues

Hereafter the key issues that need to be addressed in order to reach GSM-R/FRMCS interoperability are described.

Key issue 1 - Addressing

Addressing mechanisms in GSM-R and FRMCS are different. GSM-R is using MSISDN based and Functional Number based addressing and FRMCS is using MCPTT ID based and Functional Alias based addressing.

The addressing methods are different in the structure of the numbering and also in the length of the addresses.

GSM-R uses UUS for transferring the calling user FA towards the called user.

Gap:

- Convert GSM-R UUS information towards FRMCS user.
- Convert FRMCS FA into GSM-R UUS information towards the GSM-R user.

Key issue 2 - Call initiation with FA

If the FA structure is not the same in GSM-R and FRMCS then Functional Number needs to be converted to FRMCS FA format (see ETSI TS 123 379 [i.10], clause 5.16.1).

Gap:

- Convert called FN towards FRMCS system.
- Convert called FA towards GSM-R system.

Key issue 3 - Call routing towards FRMCS based on FA

If the called FA is an FRMCS user FA, then GSM-R system decides how to route the call to the FRMCS system.

Gap:

- Based on which information the GSM-R system route the call towards FRMCS system.

Key issue 4 - Call initiation with MSISDN

A GSM-R user initiates the P2P with MSISDN number, but MSISDN number is not interpreted by FRMCS network as the FRMCS network uses MCPTT ID.

Gap:

- Convert MSISDN number to MCPTT ID or MCPTT FA.

Key issue 5 - GSM-R user presence service in FRMCS system

Only those FRMCS users who are registered and presented to the MCPTT server initiate and receive MCPTT private calls. If a GSM-R user wants to initiate or receive calls to/from FRMCS system, then those GSM-R users need to be registered and presented to the MCPTT server (see Table 7).

Table 7: Extract from 3GPP TS 22.889 [i.3], clause 12.4.5

Reference Number	Requirement text	Application/Transport	SA1 spec covering	Comments
[12.4-001]	FRMCS System shall provide a means for an FRMCS User to present the presence status of GSM-R User, including user ID, states (e.g. available, busy, etc.), etc.	A	Not covered	No presence mechanism in MCX. No presence mechanism in GSM-R. Alternative: place a call to a GSM-R user to check presence.
[12.4-002]	FRMCS System shall provide a means to share the presence status of FRMCS User(s) to GSM-R, including user ID, states (e.g. available, busy, etc.), etc.	A	Not covered	No presence mechanism in MCX. No presence mechanism in GSM-R.

Key issue 6 - Call model harmonization

3GPP describes the call model for GSM, IMS and MC, which are different, i.e. all call flows for interworking need to be considered on a case by case basis.

Gap:

- GSM-R and MCPTT call models need to be harmonized.

Key issue 7 - Codec negotiation

GSM-R system and FRMCS system (considering MCPTT server within FRMCS system) support many different types of codecs. If there is at least one common codec, this needs to be selected for the GSM-R - FRMCS private call.

Gap:

- If there is no common codec, then transcoding is needed.

Key issue 8 - Floor control in P2P calls

No floor control interworking is specified between GSM-R and FRMCS. Both networks manage the floor control only locally, neither of the systems forwards the floor control information towards the other system.

Gap:

- Floor control information needs to be exchanged between GSM-R and FRMCS.

Key issue 9 - Location

Short call dialling with location information.

When a short code is dialled from GSM-R system (e.g. local dispatcher call), but the dispatcher centre is located in the FRMCS system, then, together with the short code, the GSM-R user location needs to be forwarded towards the FRMCS system or vice versa (see ETSI TS 123 379 [i.10] Key issue 16-4).

Gaps:

- GSM-R location information needs to be converted to FRMCS location information.

- FRMCS location information needs to be converted to GSM-R location information.

From 3GPP TS 22.889 [i.3], clause 12.3 Location Service interworking between GSM-R and FRMCS Users: this use case allows FRMCS System and GSM-R system to obtain and share the location information of their users.

Gaps:

- IWF needs to convert location request from FRMCS to GSM-R and convert response from GSM-R to FRMCS.
- IWF needs to convert location request from GSM-R to FRMCS and convert response from FRMCS to GSM-R.

Key issue 10 - Encryption

End-to-End Encryption: Encryption that is applied by an originating terminal or client and is decrypted only by chosen terminating terminals or clients.

MCPTT system, decides whether to encrypt the media using 3GPP mechanisms or not.

Gap:

- Since GSM-R system has no media encryption, end to end encryption needs to be handled and terminated in the IWF.

5.4.1.3 Potential Solutions

Solution 1 - Addressing

A GSM-R user initiate calls only by dialling digits either MSISDN (E.164) or Functional Number. This means that the FRMCS users is to be called from GSM-R system only with dialled numbers. If the FRMCS user has SIP-URI like MCPTT Service ID, then the called number string from GSM-R is to be converted to MCPTT Service ID. This conversion needs to be done in IWF based local conversion or on a preconfigured database either in the IWF or in the MCX server. If the MCPTT Service ID mapping database reside in MCX server then IWF-3 interface is required to be used to access the database.

One possibility is to allocate a tel-URI like MCPTT Service ID for all FRMCS users, but this would restrict the ID allocation as only number strings is to be allocated to FRMCS users as MCPTT Service ID.

Another possibility is to allocate a permanent tel-URI like Functional Alias to all the FRMCS users. In this case the IWF simply convert the received MSISDN or Functional Number to tel-URI and initiate the private call towards MCX server with it.

Alternative options for a GSM-R user calling an FRMCS user with MSISDN are shown in Figure 11, Figure 12 and Figure 13.

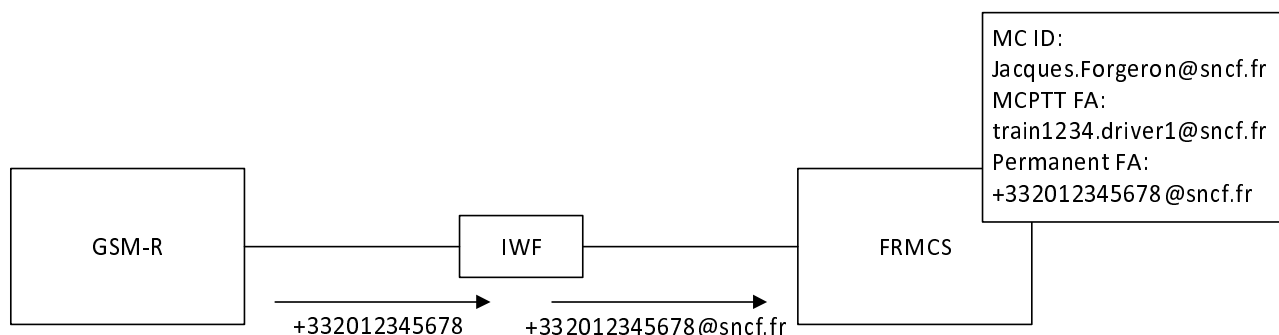

Figure 11: Number string is allocated as permanent FA

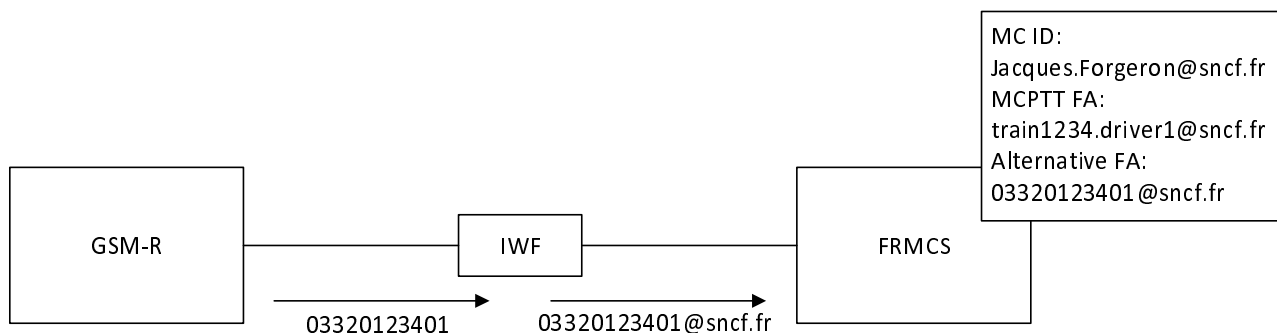

Figure 12: EIRENE number string is allocated as permanent FA

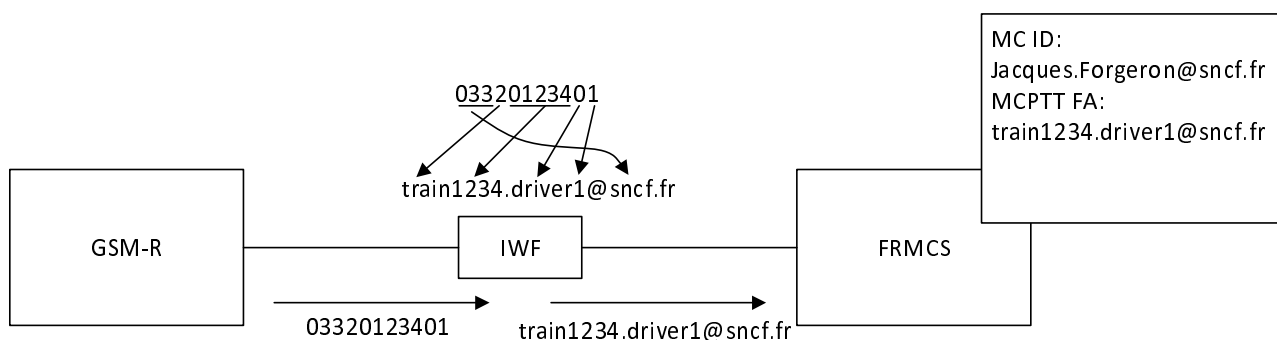

Figure 13: Local conversion to be applied based on rules derived from EIRENE depends on the FA structure

Solution 2 - Call initiation with FA

It is described how a call routing could be done for a call using functional alias for originating and destination address. It is assumed, that no routable destination addresses are estimated in the originating network, which corresponds to scenario where a copied database has been used by the IWF to estimate the address to be interworked.

If a call using a Functional Alias/Addressing for originating and destination in FRMCS or in GSM-R, the system where the session request was originated first look up in the originating network for a routable destination address. If a routable destination in the other network was estimated, by default or by database, the call is to be send to the IWF using the target address. The interworking function needs to translate all functional addresses into an understandable destination format.

In Figure 14 below it has been assumed that the source and destination addresses are harmonized for the user part and do not have to be translated. Using fixed translation rules might be also possible.

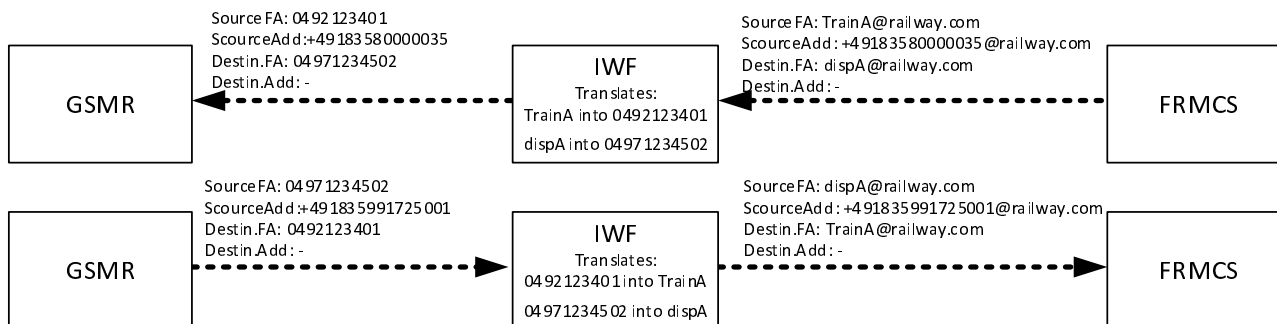

Figure 14: Interworking originating and destination functional alias/addressing

Solution 3 - Call routing towards FRMCS based on FA

See Solution 2.

Solution 4 - Call initiation with MSISDN

A routable identity for both systems needs to be offered and shared for functional alias and addressing.

It is proposed to introduce an indication in call control signalling in the MCX system for the following types of calls:

- MCX user towards GSM-R user.
- GSM-R user towards MCX user.

The new indication identifies those call requests as belonging to a one-to-one call where one endpoint is part of an MCX system, and one endpoint is part of GSM-R. The new indication is included in signalling by MCX UEs and by the interworking function IWF. MCX UE includes this indication based on e.g. the number format (leading 0 or +), length of called number, country code or network destination code.

The new indication allows involved MCX servers to identify as being a "telephony type" call. This allows the MCX server to:

- apply correct policy, e.g. priority as appropriate;
- apply services as needed, e.g. barring of calls;
- ensure correct codec usage.

Solution 5 - GSM-R user presence service in FRMCS system

Not applicable.

Solution 6 - Call model harmonization

Based on our analysis no extra harmonization is needed.

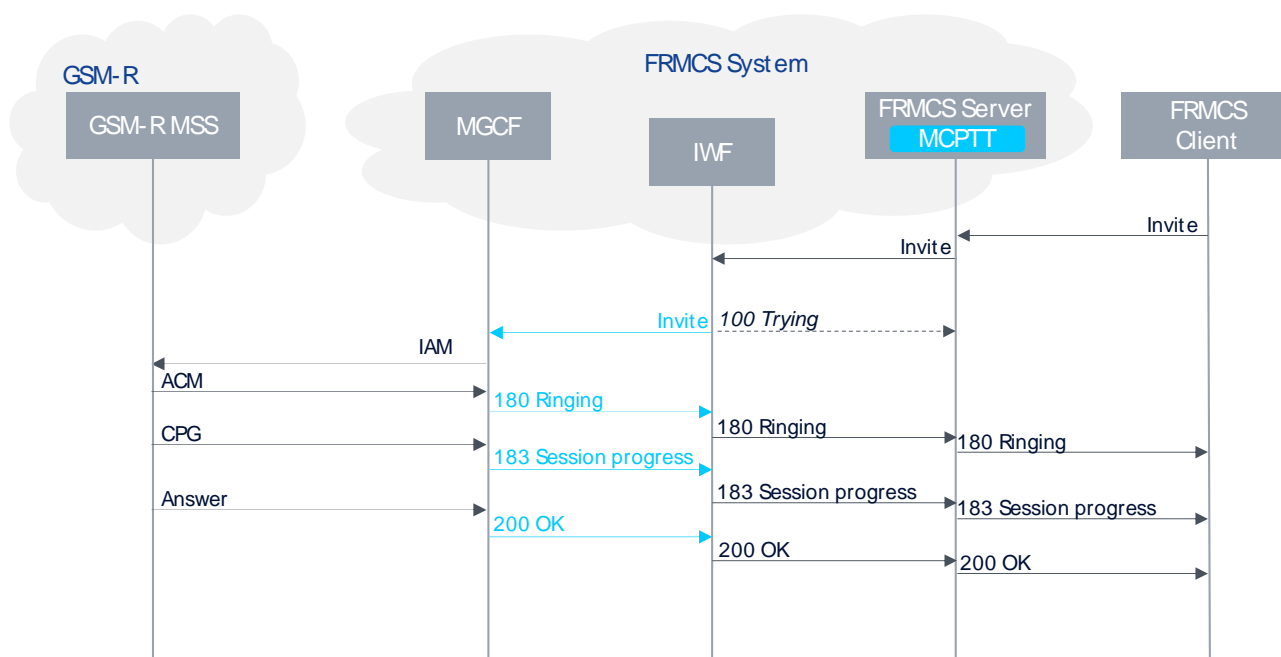

Figure 15: Example of IWF between GSM-R and FRMCS

The MGCF can be seen either as part of the FRMCS System or of the GSM-R one based on the customer deployment status.

NOTE 1: FRMCS System potentially contain CSCF proxies between the shown network elements.

Solution 7 - Codec negotiation

Each MGCF that is connected to any IWF needs to support AMR-WB codec.

If the MGCF realizes that the P2P call needs to be routed towards FRMCS (via IWF), then MGCF selects the AMR-WB codec for the outgoing MGW resource. In this way a known codec is selected for the FRMCS system and IWF does not need to modify it. See also Figure 16.

NOTE 2: No MGW control is needed by IWF in this case.

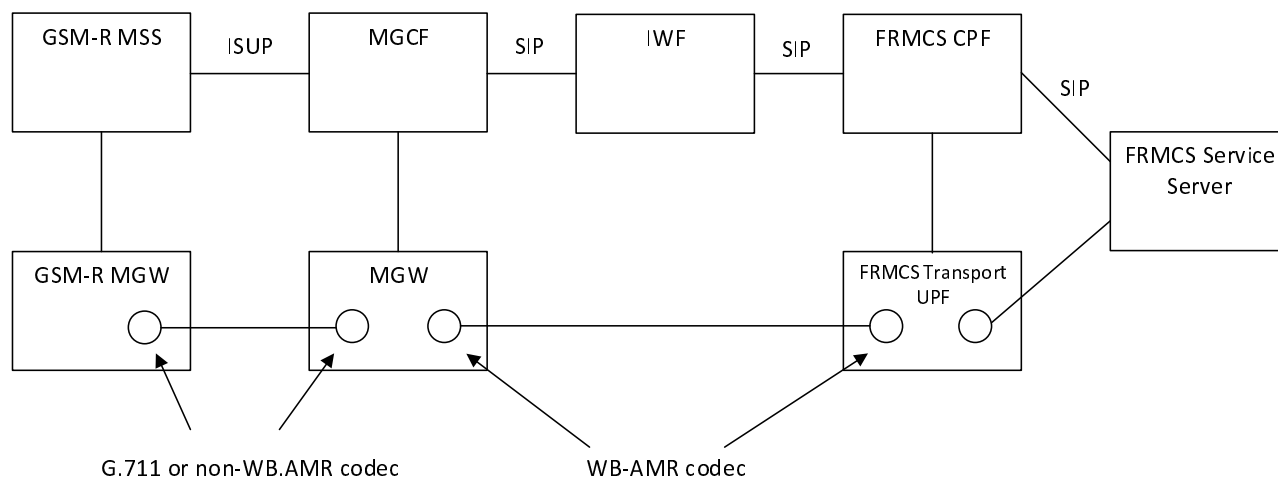

Figure 16: Codec Negotiation

Solution 8 - Floor control in P2P calls

The general approach would be to ban private calls with floor control as there is no similar functionality in GSM-R system. The proposal is to either restrict the initiation of private calls with floor control or somehow downgrade those to private calls without floor control.

When a private call with floor control is initiated in GSM-R (towards an FRMCS user), no problem is foreseen as the IWF indicates all the P2P calls from GSM-R as private calls without floor control towards FRMCS.

When a private call with floor control is initiated in FRMCS (towards a GSM-R user), the MCX system does not notify that floor control is not supported or downgrade the call to a private call without floor control. It is therefore necessary for the MCX Server to notify the MCX Client about the floor control parameters change. More in detail, the controlling MCX Server, once it realises that the called user is a GSM-R user:

- Changes the floor control indication in the [SIP:INVITE](#) message.

Notify the MCX FRMCS Client about this modification in the floor control parameter.

The information elements for the IWF private call response to be applied are shown in Table 8 below (see ETSI TS 123 283 [i.13], clause 10.4.1.3).

Table 8: IWF private call response information elements

Information Element	Status	Description
MCPTT ID	M	The MCPTT ID of the calling party.
MCPTT ID	O	The MCPTT ID of the called party.
Acceptance confirmation	O	An indication whether the user has positively accepted the call.
SDP answer	M	Media parameters selected.
Result	M	Result of the IWF private call request: success or failure.
Encryption Algorithm(s) response	O	A list of one or more alternative encryption algorithm(s) to use for the call.
Use floor control indication response	O	This element indicates whether the floor control indication in the request is acceptable.
Implicit floor request response	O	This element indicates whether the indication that the user is also requesting the floor in the request is acceptable.

ETSI TS 123 283 [i.13], clause 10.4.2.1 point 5 describes the following steps:

"The MCPTT server forwards the MCPTT private call response to the MCPTT client. If the result parameter indicates success, then the MCPTT client proceeds to step 6. Otherwise, if the parameters returned in the MCPTT private call response are acceptable to the MCPTT client, then the MCPTT client send a new MCPTT private call request with the new parameters and behaves according to those parameters. The calling MCPTT user is to be potentially notified of the change in parameters, for example, that the call is to be without floor control. The MCPTT user choose to end the call rather than continue with the new parameters. If the parameters returned are not acceptable to the MCPTT client, then the call fails."

Restriction of private calls with floor control towards GSM-R users needs to be assured in the whole FRMCS system.

Solution 9 - Location

Not applicable. It is limited to LDA/eLDA and no exchange of location information between systems is foreseen.

NOTE 3: Following clarification from UIC, location is not needed for Interworking.

Solution 10 - Encryption

As there is no encryption in GSM-R system, An MC client initiates a private call towards GSM-R system without encryption.

Relevant clause from ETSI TS 123 283 [i.13] to be applied:

ETSI TS 123 283 [i.13], clause 10.4.2.1 MCPTT user initiating an MCPTT private call:

The MCPTT user at the MCPTT client initiates an MCPTT private call. The MCPTT client sends an MCPTT private call request towards the MCPTT server. The MCPTT private call request contains the MCPTT IDs corresponding to the calling MCPTT party and called LMR party and an SDP offer containing one or more media types. If available, the MCPTT user at the MCPTT client also include a functional alias if needed. The following parameters are also included that describe the MCPTT client's choices:

- the encryption algorithm;
- **the encryption mode (encrypted or not);**
- an indication of whether the MCPTT client is requesting the floor, and if the MCPTT client is requesting the floor, location information of the calling MCPTT client is be provided if needed;
- requested commencement mode (automatic in this case); and
- an indication of whether the call is to be full or half duplex (whether to establish floor control).

5.4.2 Interworking of group calls

5.4.2.1 General

This clause describes the mode of operation of group calls in MCPTT and in GSM-R. It highlights the key issues and contains proposed solutions. The current version of the present document covers interworking of VGCS in GSM-R with non-broadcast group calls in MCPTT. However similar principles are to be used for interworking of VBS in GSM-R and broadcast group call in MCPTT.

Table 9: Summary of characteristics of group calls in GSM-R and MCPTT

GSM-R	MCPTT
Group call location dependency is based on cells which are stored in the GCR. If the cells are served by different MSCs, the list of the relay MSCs is also stored	Group calls are based on pre-arranged group calls. Location dependency is done via automatic affiliation/de-affiliation performed by the client. Location definition is not cell based, but rather based on geometric shapes (polygon, ellipsoid, ...). Additional dependency on speed and direction possible
Group membership for dispatchers in GCR, for service subscribers via SIM card	Group membership
No concept of affiliation	Affiliation
GCR contains the list of dispatchers to which a dedicated link is to be established, and: <ul style="list-style-type: none"> list of dispatchers that are allowed to initiate the GC list of dispatchers that are allowed to terminate GC information on the codecs allowed for this voice group call. the default priority level related to the voice group call 	No dedicated dispatcher list, dispatchers follow "normal" group membership and affiliation principle, New feature planned in stage 3: "MC service server prevents de-affiliation when using a specific functional alias(es)"
No activity timer Conditions to stop/restart timers	Inactivity timer and other timers like TNG3 (group call timer), TNG2 (in-progress emergency group call timer), ... Conditions to stop/restart timers
RANFlex configuration related to redundancy	No RANFlex equivalent
Dispatchers and service subscribers use different means for talker control: <ul style="list-style-type: none"> Service subscribers use uplink control Dispatchers use always talk and use mute/unmute to ensure talking service subscriber hear the dispatcher's audio 	Dispatchers and service subscribers use common means for talker control: <ul style="list-style-type: none"> Floor control

Table 9 clearly highlights that group calls in MCPTT and in GSM-R work in very different ways. As a result, interworking a group call in MCPTT with a group call in GSM-R result in a different characteristic compared with a group call within one of the systems. The present document proposes possible solutions that try to keep the overall complexity low and, at the same time, minimize the impact on the user experience.

5.4.2.2 Key Issues

As listed in Table 9 call control logic of the group calls is based on different principles in GSM-R and in MCPTT. Interworking of MCPTT and GSM-R group calls effectively means combining both the MCPTT and GSM-R group into one new group that contains all the applicable users from GSM-R and MCPTT. The following needs to be addressed:

- 1) how to ensure that all applicable users from the GSM-R system and the MCPTT participate in the call;
- 2) how to interwork floor control on MCPTT with uplink control and dispatcher mute/unmute in GSM-R;
- 3) how to interwork the media codecs between GSM-R and MCPTT;
- 4) how an existing anchor/relay setup in GSM-R affects the interworking;
- 5) how to handle the different timers in GSM-R and MCPTT;
- 6) how RANFlex in GSM-R affects the interworking.

5.4.2.3 Potential solutions

5.4.2.3.1 Interworking of the group call

The IWF affiliates to an MCPTT group with a single affiliation on behalf of all GSM-R group members. A single IWF group call request/IWF group call release request message is sent to the IWF at the commencement/release of a group call. The combining of the group calls is achieved by a call leg from the system on which the group call is originated to the other system (e.g. if the group call is originated in the GSM-R system, the GSM-R system additionally initiates a group call towards the IWF into the MCPTT system). The call leg between the systems has a duplex voice path. Figure 17 illustrates the principle of group call interworking.

Prerequisites:

- 1) The GSM-R system needs to be aware that the group includes an MCPTT group that is defined in the MCPTT system. This is done by adding the Address of the IWF user representing the MCPTT group to the GCR.
- 2) The MCPTT system needs to be aware that the group includes a GSM-R group that is defined in the GSM-R system. This is done by adding the Address of the IWF user representing the GSM-R group.

For a group call that is originated in GSM-R by a dispatcher or a service subscriber, the GSM-R system sends out an IWF group call request to the IWF. For a group call that is originated in MCPTT by a dispatcher user, the MCPTT system sends an IWF group call request out to the IWF.

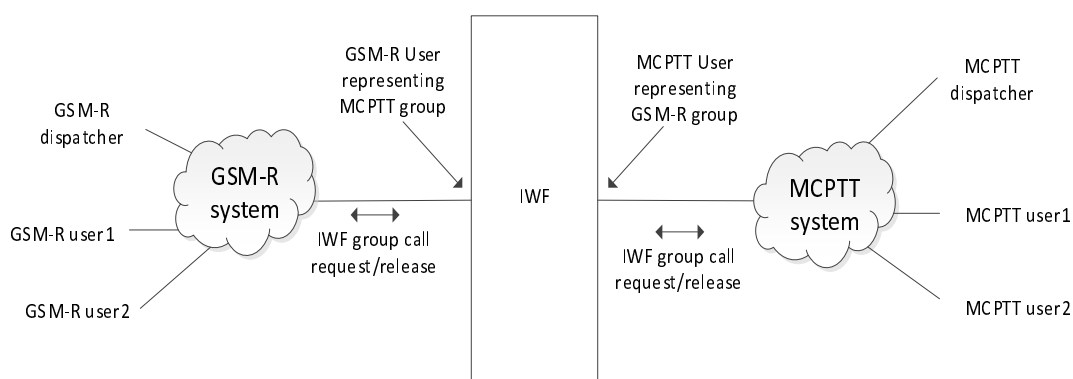

Figure 17: Group call interworking principle

This approach is based on the solution described in clauses 10.3.1 and 10.3.3 in ETSI TS 123 283 [i.13]. Figure 18 and Figure 19 illustrate the procedures for interworking of group calls that are initiated from the MCPTT or from the GSM-R side.

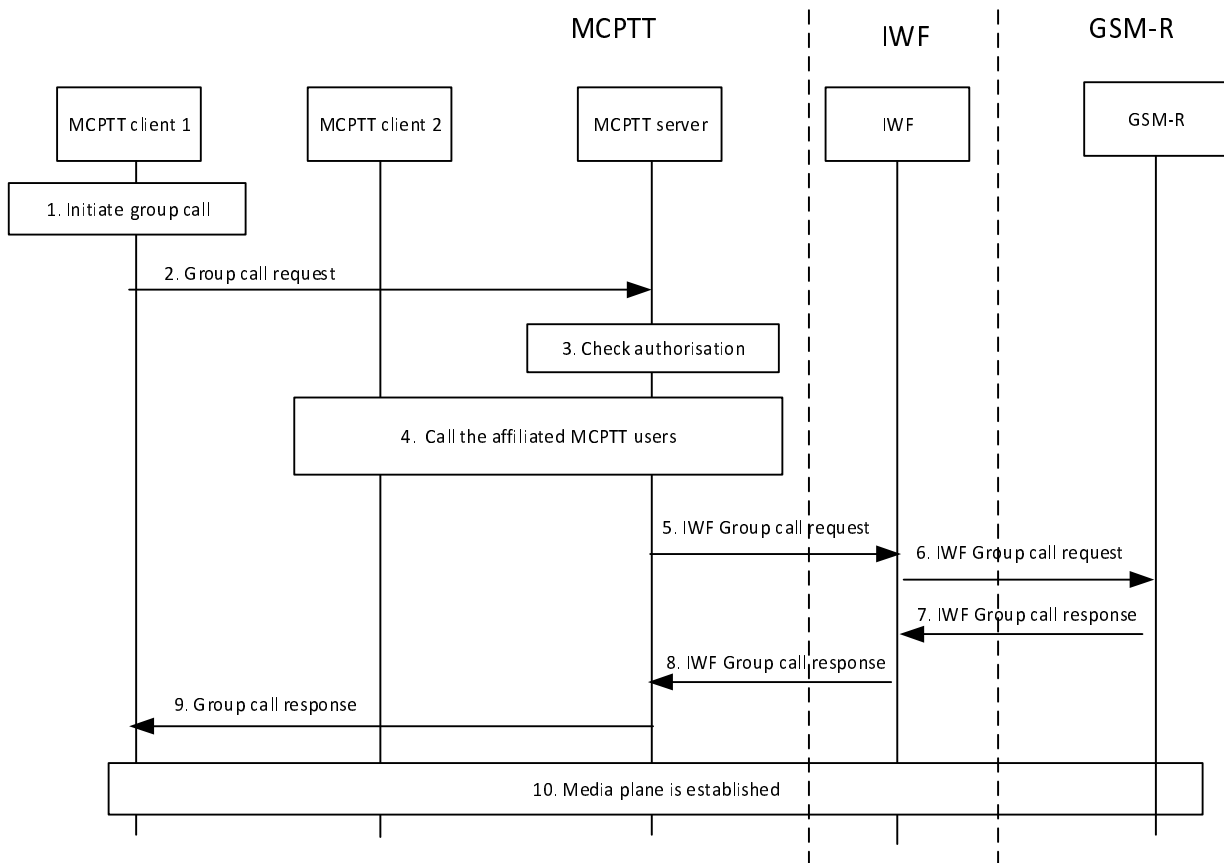

Figure 18: Group call setup initiated by MCPTT user on an interworking group defined in MCPTT system

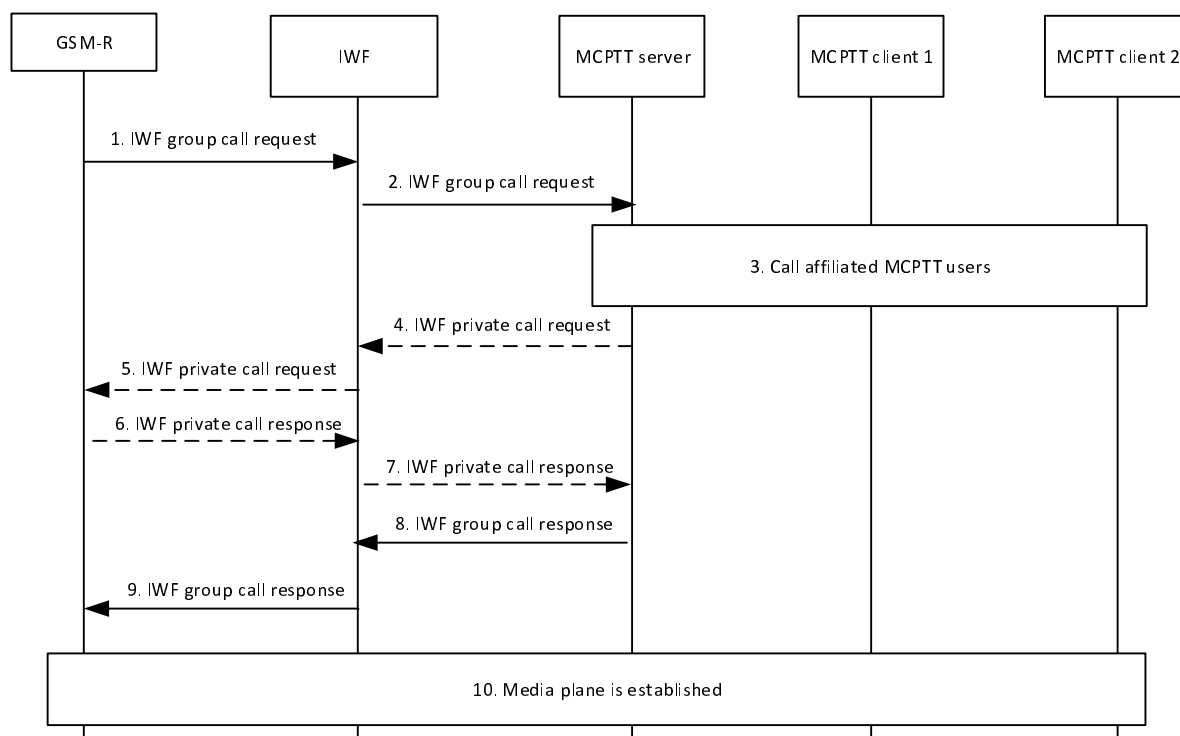

Figure 19: Group call initiated by GSM-R user on an interworking group defined in MCPTT system

In Figure 19, the actual group call is initiated in step 2. The steps 4 to 7 are optional and would only occur if additionally individual GSM-R users (typically dispatchers connected to the GSM-R network, but provisioned in the MCPTT system) are included in the interworking group call.

5.4.2.3.2 Interworking talker control in MCPTT and GSM-R

5.4.2.3.2.1 General

As illustrated in Table 9 both systems use different means for talker control:

- GSM-R.
- For service subscribers uplink control is used.
- Dispatchers always talk, but to ensure that a service subscriber that has the uplink granted hears the dispatcher talking, the dispatcher unmutes the downlink at any time.
- MCPTT uses floor control for talker control for both dispatchers and "other" users.

The following clauses describe a proposed solution to interwork these different means to have a consistent behaviour in the interworking group call.

5.4.2.3.2.2 Proposed requirements

The following requirements are proposed to be used for evaluation of the solution:

- 1) The behaviour that dispatchers talk at any time in GSM-R without having to request the right to talk is to be preserved for group calls combining MCPTT and GSM-R groups.
- 2) Uplink control in GSM-R remains unaffected for group calls MCPTT and GSM-R groups.

- 3) Floor control in MCPTT remain unaffected in MCPTT.
- 4) Impact on user experience is to be minimized.

5.4.2.3.2.3 Proposed solution

A proposed solution for interworking of talker control is described hereafter.

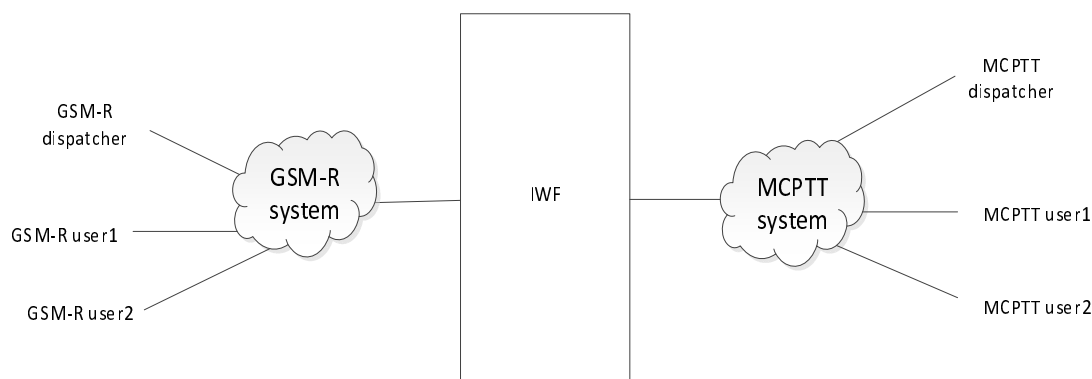

Figure 20: Simplified representation for illustration of the approach

For all the use cases below the following prerequisites apply:

- The IWF affiliates to an MCPTT group with a single affiliation on behalf of all GSM-R group members.
- The MCPTT group has the optional multi talker control configured. For the duration of the call one of the talkers is allocated by the IWF.
- A group call is established according to one of the options describes in clause 5.4.2.3.1.

Use case 1: Service subscriber 1 in GSM-R has an uplink granted. GSM-R dispatcher wants to talk.

- 1) Service subscriber 1 talks and his audio is transmitted to all users in the GSM-R group as well as to all the users in the MCPTT group through the IWF.
- 2) Dispatcher in GSM-R wants to talk and unmutes the downlink.
 - a) Actions on GSM-R side: No change compared to current handling, uplink of service subscriber is unmuted.
 - b) Action on IWF: none.
 - c) Action on MCPTT: none.
- 3) Audio of GSM-R (containing the mixed audio of the dispatcher and the service subscriber 1) is still transmitted to MCPTT and mixed there. Audio from MCPTT is transmitted to GSM-R and mixed there. All users in the MCPTT group and the GSM-R group hear the same audio.

Use case 2: Service subscriber 1 in GSM-R has an uplink granted. Change of uplink to other service subscriber in GSM-R.

- 1) Service subscriber 1 talks and his audio is transmitted to all users in the GSM-R group as well as to all the users in the MCPTT group through the IWF.
- 2) Service subscriber 1 releases the uplink.
 - a) Actions on GSM-R side: No change compared to current handling.
 - b) Action on IWF: none.

- c) Action on MCPTT: none.
- 3) Service subscriber 2 in GSM-R requests and gets the uplink.
- 4) Service subscriber 2 talks.
 - a) Actions on GSM-R side: No change compared to current handling.
 - b) Action on IWF: none.
 - c) Action on MCPTT: none.
- 5) Audio of GSM-R service subscriber 2 is transmitted to MCPTT and mixed there. Audio from MCPTT is transmitted to GSM-R and mixed there. All users in the MCPTT group and the GSM-R group hear the same audio.

Use case 3: Service subscriber 1 in GSM-R has an uplink granted. MCPTT dispatcher wants to talk.

- 1) Service subscriber 1 talks and his audio is transmitted to all users in the GSM-R group as well as to all the users in the MCPTT group through the IWF.
- 2) Dispatcher in MCPTT wants to talk. The floor is requested and based on floor availability in MCPTT, it is granted. Once the floor is granted, the IWF is treated like any other MCPTT user and get a floor taken message from the server.
 - a) Actions on MCPTT: No change compared to current handling.
 - b) Action on IWF: IWF receives and detects floor taken message coming from the MCPTT server. The IWF converts that message into a unmute message and sends that towards GSM-R.
 - c) Action on GSM-R side: No change compared to current handling, uplink of service subscribe is unmuted.
- 3) Audio of GSM-R (containing the mixed audio of service subscriber 1) is transmitted as well to MCPTT and mixed there. Audio from MCPTT is transmitted to GSM-R and mixed there. All users in the MCPTT group and the GSM-R group hear the same audio.

Use case 4: Service subscriber 1 in GSM-R has an uplink granted. MCPTT user wants to talk.

This use case works exactly like use case 3 above described.

Use case 5: Change of floor ownership in MCPTT.

This use case is very similar to use case 4. The only difference is the following:

- 1) MCPTT user 1 has the floor granted and talks. As stated in use case 4 the downlink in GSM-R is unmuted. Service subscriber in GSM-R hear the audio from MCPTT.
- 2) MCPTT user 1 releases the floor. Floor in MCPTT is idle, which is detected by the IWF. IWF sends a mute downlink towards GSM-R.
- 3) MCPTT user 2 requests the floor and gets it.
- 4) IWF receives and detects floor taken message coming from the MCPTT server. The IWF converts that message into a unmute message and sends that towards GSM-R.
- 5) Service subscriber in GSM-R hear the audio from MCPTT.

5.4.2.3.2.4 Evaluation of the proposed solution

The following clause describes what key issues are addressed by the proposed solution, and to what degree the requirements are met.

The proposed solution addresses the key issues identified in clause 5.4.2.2 as follows:

How to ensure that all applicable users from the GSM-R system and the MCPTT participate in the call

This is accomplished by using the data and service logic in each system separately and composing the group by connecting these groups in one call.

How to interwork floor control on MCPTT with uplink control and dispatcher mute/unmute in GSM-R

To maintain the behaviour that dispatchers in GSM-R talk at any time, and to ensure that MCPTT dispatchers also talk to GSM-R users at any time the proposed solution is based on converting floor taken messages in MCPTT into unmute messages in GSM-R. Utilizing multi talker control in MCPTT allows uncoupling of uplink and unmute requests in GSM-R from MCPTT.

How to interwork the media codecs between GSM-R and MCPTT

IWF perform transcoding. Details depend on specific codecs.

How does an existing anchor/relay setup in GSM-R affect the interworking

The proposed solution of using the data and service logic in each system separately and composing the group by connecting these groups in one call avoids impact on anchor relay setup in GSM-R, as the relay is hidden from MCPTT.

How to handle the different timers in GSM-R and MCPTT

Timers run independently. For best user end to end experience, certain timer values are to be aligned.

How does RANFlex in GSM-R affect the interworking

The proposed solution of using the data and service logic in each system separately, and composing the group by connecting these groups in one call avoids impact on RANFlex in GSM-R.

The proposed solution addresses the requirements defined in clause 5.4.2.3.2.2 as follows:

The behaviour that dispatchers talk at any time in GSM-R without having to request the right to talk is to be preserved for group calls combining MCPTT and GSM-R groups.

Compliant.

Uplink control in GSM-R remain unaffected for group calls MCPTT and GSM-R groups.

Compliant.

Floor control in MCPTT remain unaffected in MCPTT.

Compliant by utilizing multi talker control in MCPTT.

Impact on user experience is to be minimized.

The end user experience for originating group call spawning GSM-R and MCPTT is not different from originating a group call in a single system. As talker control is kept locally in GSM-R and MCPTT there is also no direct impact on user experience for talker control. The only difference is on the number of simultaneous talkers. In addition:

- Users in GSM-R additionally hear the audio of MCPTT users that are permitted to talk (and talk) in the MCPTT system (depending on settings of multi talker control). Currently a GSM-R service subscriber hear his own echo while the downlink is unmuted by the IWF (as it is currently the case in GSM-R while dispatchers talk).
- Users in MCPTT additionally hear the audio of GSM-R dispatchers and the service subscriber that has the uplink.
- For GSM-R groups interworking with MCPTT, a GSM-R user representing the MCPTT group has to be added to the GCR.
- For MCPTT groups interworking with a GSM-R, user representing the GSM-R group has to be added to the MCPTT group definition.

5.4.3 Interworking of SMS, MCDData message

5.4.3.1 General

GSM-R system includes Mobile Stations (MS) which perform different types of calls, such as voice calls, data calls, but also offer the possibility to do text messaging, i.e. transmit Short Messages (SMS) between mobile stations. EIRENE System Requirements Specification [i.19] specifies that, whenever text messaging is implemented in the GSM-R network, the Short Message Service (SMS) - as known for the GSM standard - is to be used (see section 12.2.1 of [i.19]).

The short message service and short messages are defined in the ETSI TS 123 040 [i.4]. In a GSM-R network, the Short Messages (SMS) are typically transported by using the capabilities of the "Mobile Application Part" (MAP) protocol as specified in the ETSI GTS GSM 09.02 [i.15] specification. The MAP protocol provides a mechanism to transport the messages between the mobile stations and the so-called "Short Message Service Centre" (SMSC). According to the GSM SMS specification, a "Service Centre" is defined as a function responsible for the relaying and store-and-forwarding of a short message between a Short Message Entity (SME), i.e. an entity which send or receive Short Messages, and a Mobile Station. Furthermore, an open industry standard protocol, called "Short Message Peer to Peer" (SMPP) protocol, developed by the SMPP Developers Forum, is typically used for the transport between the SMSC and any SMS application server which is connected via a permanent TCP/IP connection.

The present interworking scenario specifies Short Data Service (SDS) interworking between GSM-R users and MCDData clients using one-to-one standalone SDS messages. The IWF behaves as a peer MCDData server to other MCDData servers on the FRMCS side and as a peer SMSC on the GSM-R side.

When a GSM-R user attempts to send a GSM-R message to the MCDData service, the IWF converts the GSM-R message into a request to send an MCDData SDS. When an MCDData user sends an SDS to the GSM-R system the IWF converts the message to SMS over SIP and converts the destination and originating address using the same mapping techniques as in point-to-point voice calls. The IWF then forwards the SMS via the IP-SMS-gateway to the GSM-R SMSC.

5.4.3.2 IWF MCDData SDS Information Flows

This clause defines information flows for MCDData SDS on the IWF-2 interface. MCDData SDS related information flows on reference points other than IWF-2 are defined in ETSI TS 123 282 [i.11], clause 7.4.2.1. In each case, the GSM-R users behind the IWF are represented by MCDData IDs or a MCDData group ID as appropriate and so the MCDData server is to be capable of routing messages towards identities located behind the IWF.

Table 10 and Table 11 below describe the information elements for the MCDData standalone data request (in ETSI TS 123 282 [i.11], clauses 7.4.2.2.2 and 7.4.2.3.2) sent from the MCDData server to the IWF and from the IWF to a MCDData server and the IWF MCDData data disposition notification.

Table 10: IWF MCDData standalone data request

Information element	Status	Description
MCDData ID	M	The identity of the MCDData user sending data.
Functional alias	O	The associated functional alias of the MCDData user sending data.
MCDData ID	M	The identity of the MCDData user towards which the data is sent.
Conversation Identifier (see note)	M	Identifies the conversation.
Transaction Identifier (see note)	M	Identifies the MCDData transaction.
Reply Identifier	O	Identifies the original MCDData transaction to which the current transaction is a reply to.
Disposition Type	O	GSM-R SMS supports delivery disposition only.
Payload Destination Type	M	MCDData client consumption only.
Application identifier (see NOTE)	O	Not applicable to FRMCS.
Payload	M	SDS content.
NOTE:	A reserved value of the Information Element needs to be defined which indicates that the sender does not support this Information Element.	

Table 11: IWF MCDATA data disposition notification

Information element	Status	Description
MCDATA ID	M	The identity of the MCDATA user towards which the notification is sent
MCDATA ID	M	The identity of the MCDATA user sending notification
Conversation Identifier (see note)	M	Identifies the conversation
Disposition association	M	Identity of the original MCDATA transaction
Disposition	M	Disposition which is delivered or read or both (only delivery supported in GSM-R)
NOTE: A reserved value of the Information Element should be defined which indicates that the sender does not support this Information Element.		

5.4.3.3 Key issues

Key Issue #1 Addressing

Issue of conversion of GSM-R SMS addresses as well as Functional Numbers to corresponding MCDATA IDs.

Issue of conversion of SDS addresses to corresponding SMS addresses.

Key Issue #2 Receipt of Delivery and reading

GSM-R SMS does not support read disposition report.

Key Issue #3 message Payload Size

MCDATA supports 1 000 characters while GSM-R SMS supports 160 characters.

Key Issue #4 IWF-G3 interface

It needs to be decided whether a SMPP over SIP or a MAP interface is used.

Key Issue #5 GSM-R does not support SMS group messaging

Key Issue #6 Check alphabet non-English

Default 7-bit alphabet. Message length assumes the uncompressed GSM default 7-bit alphabet is used. See ETSI TS 123 040 [i.4], clause 9.2.3.24.1 and ETSI TS 123 038 [i.16], clause 4.

5.4.3.4 Potential Solutions

Solutions #1 Addressing

For the interworking of the MC Data SDS and the GSM-R Short Message Service the same addressing and solutions are used as for point to point and group calls.

For the point-to-point use cases GSM-R SMS to MCDATA SDS user and the vice versa MCDATA short message from MCDATA user to GSM-R Subscriber the addressing as described in clause 5.4.1.2 is to be used. The potential solution is referred to in clause 5.4.1.3.

Solutions #2 Receipt of Delivery and reading

Delivery report is possible. Read report implicit in delivery report as option.

Solutions #3 message Payload Size

Compatibility of content and method of delivery of SMS and MCDATA SDS Message size of MCDATA SDS not compatible with 160 characters limit on SMS.

Truncate payload to 160 characters.

Solution #4 IWF-G3 interface

GSM-R use of SIP of SMS signalling.

Usage of IP-SMS Gateway.

Solution #5

GSM-R SMS to MCDATA is point to point.

Support multiple SMS.

5.4.4 Interworking related to fixed line dispatcher

5.4.4.1 Controller attached to GSM-R vs FRMCS

5.4.4.1.1 Key issue

According to UIC's FRMCS use case specification [i.1], the use cases dealing with service interworking and service continuation read like the following excerpt of that document (which is taken from the use case "On-train outgoing voice communication from the driver towards the controller(s) of the train"):

6.5 Use case: Service interworking and service continuation with GSM-R

...

6.5.1.2 Depending on the migration scenario a controller is to be attached to the FRMCS system, to the GSM-R system or both. The driver is to be attached either in the GSM-R system or in the FRMCS system. Functional identities are applicable in one system only.

...

These statements can be explained from a technical point of view as follows: a controller is responsible for one (or more) area(s) of responsibility, which are logged in at the controller's device. Hence, a controller is logically attached to the GSM-R system or to the FRMCS system or to both systems. Physically, the controller's device is attached to one system (being GSM-R or FRMCS) only.

Furthermore, independent from the coverage of specific area(s) of responsibility by the GSM-R system or by the FRMCS system or by both systems, call routing to the controller's device needs to be guaranteed.

5.4.4.1.2 Potential solutions

Attachment of devices and controllers

A controller who become responsible for a specific area of responsibility registers a functional address (GSM-R) or functional alias (FRMCS) at the controller's device. The controller's device is physically attached to only one system (being GSM-R or FRMCS). Hence, calls are to be routed to the controller's device by only one system. This requires a mapping between GSM-R functional addresses and FRMCS functional aliases.

Calling device in GSM-R, controller device in FRMCS

If a user at a device attached to the GSM-R system initiates a call to a controller whose device is attached in the FRMCS system, the following process applies:

- 1) GSM-R system determines controllers called functional address (CT-7).
- 2) GSM-R system determines that the CT-7 functional address resulting from step 1) is not registered in the GSM-R system.
- 3) GSM-R system routes the call to the FRMCS system.

The following options exist for the routing decision in step 3):

- a) GSM-R system routes any call to CT-7 functional addresses which are not registered in the GSM-R system to the FRMCS system.
- b) GSM-R systems routes calls to specific CT-7 functional addresses which are marked as "FRMCS targets" to the FRMCS system.

- c) GSM-R system knows the registration status of functional aliases mapped to CT-7 functional addresses within the FRMCS system and routes calls only for registered addresses/aliases.

The options differ in the point in time when calls to an unregistered CT-7 functional address (i.e. to a controller role which is not logged in and/or not reachable) fail. For option a) and b) the reachability of a specific address/alias is known in the FRMCS system only, for option c) it is known in both systems.

Calling device in FRMCS, controller device in GSM-R

If a user at a device attached to the FRMCS system initiates a call to a controller whose device is attached in the GSM-R system, the following process applies:

- 1) FRMCS system determines controllers called functional alias.
- 2) FRMCS system determines that the functional alias resulting from step 1) is not registered in the FRMCS system.
- 3) FRMCS system routes the call to the GSM-R system.

The following options exist for the routing decision in step 3):

- a) FRMCS system routes any call to functional aliases which are not registered in the FRMCS system to the GSM-R system.
- b) FRMCS systems routes calls to specific functional aliases which are marked as "GSM-R targets" to the GSM-R system.
- c) FRMCS system knows the registration status of CT-7 functional addresses mapped to functional aliases within the GSM-R system and routes calls only for registered addresses/aliases.

The options differ in the point in time when calls to an unregistered functional alias (i.e. to a controller role which is not logged in and/or not reachable) fail. For option a) and b) the reachability of a specific address/alias is known in the GSM-R system only, for option c) it is known in both systems.

Annex A: Proposal of Translation Rules for eMLPP Parameters

The RPH is to be used at the interface between MGCF and IWF, similar to what is defined in ETSI TS 103 389 [i.6]:

- only Q.735 values are allowed (0, 1, 2, 3, 4);
- only one RPH is allowed with only one value.

Between IWF, MCX AS and MCX UE the RPH is to be used according to IETF RFC 8101 [i.18] (see Figure A.1), with the following proposal:

- The Q.735 value received from the MGCF at the IWF is to be kept as additional information for the NG Dispatcher.

NOTE: IETF RFC 4412 [i.17] allows to have more than one priority value in the RPH, just ETSI TS 103 389 [i.6] strictly specifies only one Q.735 value is to be used. This implies that the MCX AS and the SIP Core (in particular the P-CSCF) handle RPH with more than one value. Only the value according to IETF RFC 8101 [i.18] is to be considered, the Q.735 value is to be ignored.

- If the NG Dispatcher - or any other element - e.g. the MCX AS - sends in the RPH an additional Q.735 value towards the MGCF, then the IWF ignores the value according to IETF RFC 8101 [i.18] and transparently forwards the Q.735 value to the MGCF. The IETF RFC 8101 [i.18] value is to be removed from the INVITE.

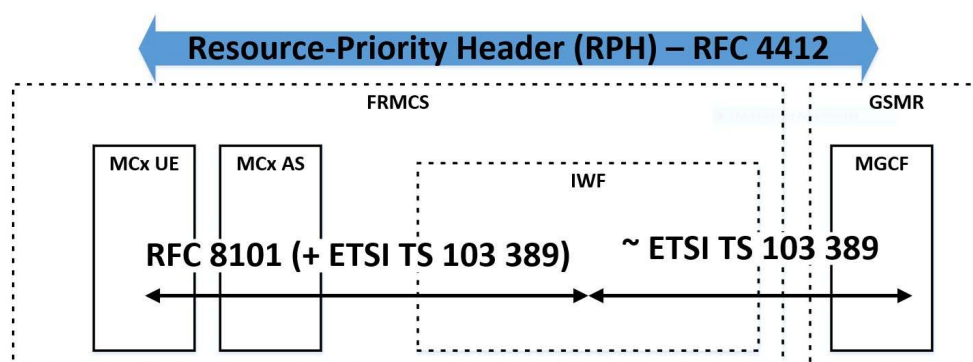

Figure A.1: Handling of the RPH

History

Document history		
V1.1.1	September 2022	Publication